

Ganymed[®]- Rohrdrehgelenke

Ganymed[®]- Swivel Joints



Inhalt

Contents

Grundlagen - Bauformen / Auswahlübersicht	3	Basics - Models / selection guide	3
Bestellbeispiele	5	Ordering examples	5
Allgemeine Informationen	6	General information	4
Baureihen		Series	
SJF	8	SJF	8
SJG	14	SJG	14
SJE	21	SJE	21
SJK	25	SJK	25
SJD	29	SJD	29
SJC	31	SJC	31
SJN	33	SJN	33
SDG	35	SDG	35
SDF	37	SDF	37

Wir stellen Ihnen 3D-CAD-Daten zur Verfügung –
Bitte unter info@haag-zeissler.com anfordern.

We provide you with 3D-CAD data –
Please send requests to info@haag-zeissler.com



Grundlagen - Bauformen / Auswahlübersicht

Basic - Models / selection guide

Rohrdrehgelenke bieten infolge eines durchgehend freien Querschnittes einen ungehinderten Durchfluß von flüssigen oder gasförmigen Medien innerhalb zwei sich bewegender Komponenten. Eine 360° Verdrehbarkeit auf einer oder mehreren Bewegungsebenen ist je nach Bauform möglich. Einsatzmöglichkeiten ergeben sich beispielsweise bei der Verladung petrochemischer Erzeugnisse, bei der Zuführung von Kühl- oder Heizmedien u. v. m.

Our Swivel Joints offer an unobstructed passage and thus a free passage of fluid or gaseous media between two equipment components moving independently from each other. The available designs permit a swivelling angle of up to 360° at one or several levels. The range of applications includes the transfer of petrochemical products, the input of cooling or heating media and much more.

Baureihe	Medien	Wasser	Luft/Vakuum	Dampf	Wärmeträgeröl	Hydrauliköl	Kraftstoff/Gas	Kühlschmierstoff	1-Kugellaufbahn	2-Kugellaufbahnen	Größen	Max. Temp. (°C)	Max. Druck (bar)	Max. Drehzahl (1/min)	Seite
SJF		●	●	●	●	●	●		●		DN 20 - 100	200	100	< 1	8
SJG		●	●	●	●	●	●			●	DN 20 - 300	200	350	< 1	14
SJE		●	●	●	●	●	●			●	DN 125 - 700	200	40	< 1	21
SJK		●	●		●	●	●	●		●	1/4" - 1 1/2"	200	350	< 5	25
SJD		●	●	●	●	●	●	●	●		DN 8 - 50	200	100	< 1	29
SJC		●	●	●	●	●	●	●		●	DN 8 - 50	200	350	< 1	31
SJN		●	●	●	●	●	●	●		●	1/4" - 1 1/2"	90	200	< 5	33
SDG		●			●	●	●	●	●		1/2" - 4"	120	16	< 1	35
SDF1		●	●	●	●	●	●		●		DN 50 - 100	200	40	< 1	37
SDF2		●	●	●	●	●	●		●		DN 50 - 800	200	40	< 1	37
series	media	water	air/vacuum	steam	heat transfer oil	hydraulic oil	gasoline/gas	coolant	one ballgroove	two ballgroove	sizes	max. temp. (°C)	max. pressure (bar)	max. speed (rpm)	page

Grundlagen - Bauformen / Auswahlübersicht

Basic - Models / selection guide

Bauformen / Anschlüsse

Haag + Zeissler Rohrdrehgelenke sind im Baukastensystem mit frei wählbaren Anschlusskomponenten, wie z.B. Flanschen, Schweißenden, Innen- und Außengewinden in acht Grundbauformen lieferbar.

Designs / connections

Haag + Zeissler Swivel Joints are available in eight basic designs in the construction kit system, with freely selectable connection components such as flanges, welding ends, female and male threads.

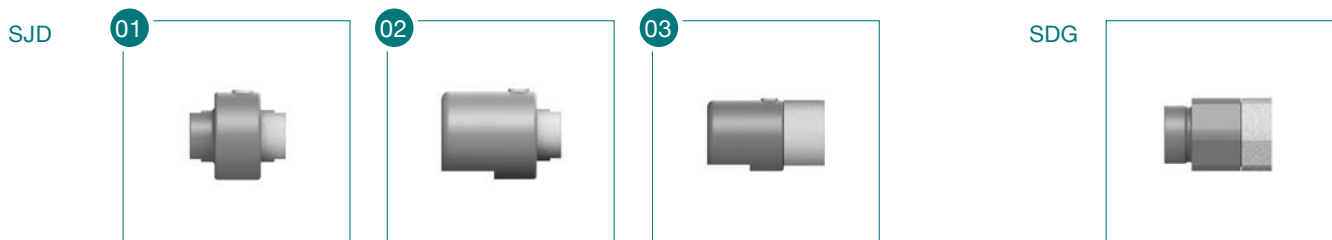
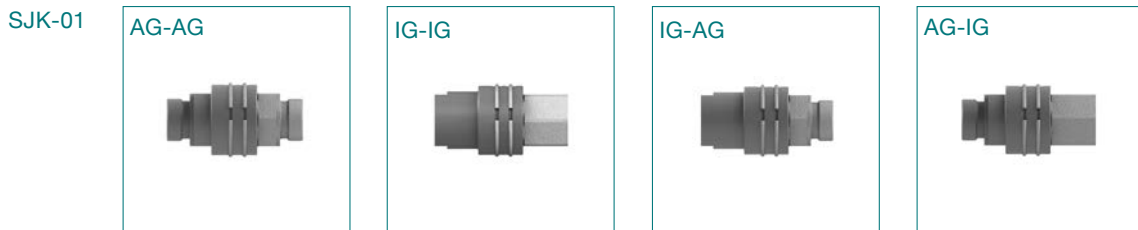
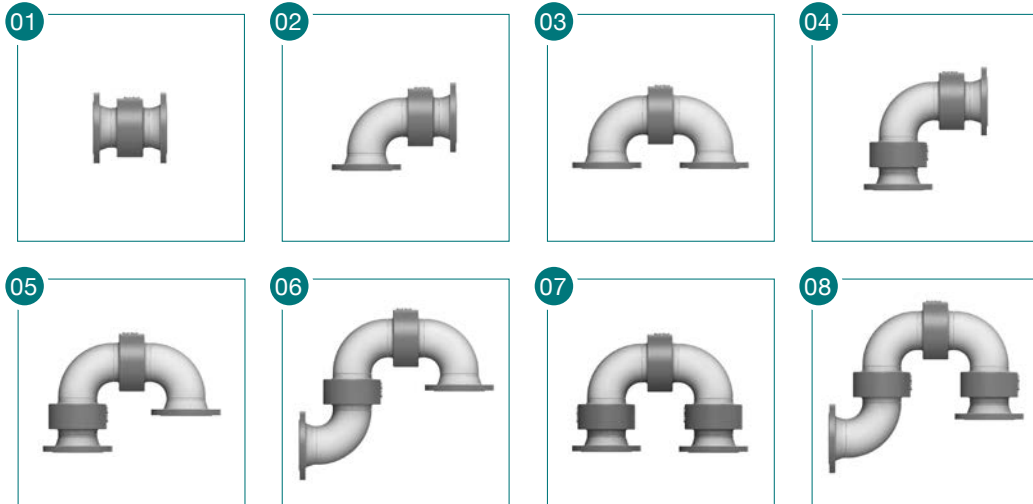

Für Pendel-, Schwenk- und Drehbewegungen.

Rohrdrehgelenke sind mit Einzel- oder Doppelkugellaufbahnen in höchster Präzision gefertigt. Weitgespreizte Laufbahnen nehmen Biegemomente, Axialschub und Radiallast auf. Als Dichtungselement kommt standardmäßig PTFE in Anwendung.

For pendulous, swivelling and rotating movements.

Our swivel joints are high-precision products with single or double ball bearing runs. Widely spaced tracks warrant the acceptance of bending loads, axial thrust and radial push. The standard sealing elements are made of PTFE.

Bestellbeispiele Ordering examples

Bestellbeispiele

Kombinationen von unterschiedlichen Anschlusselementen sind möglich

Ordering examples

Combinations of different connection elements are possible

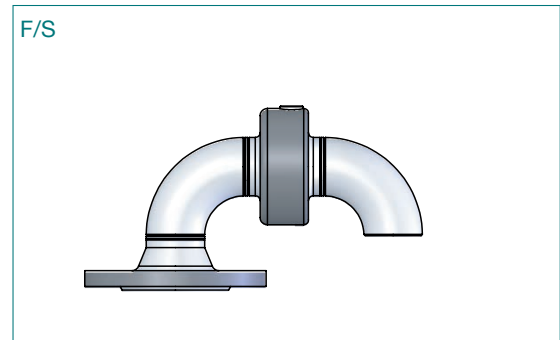
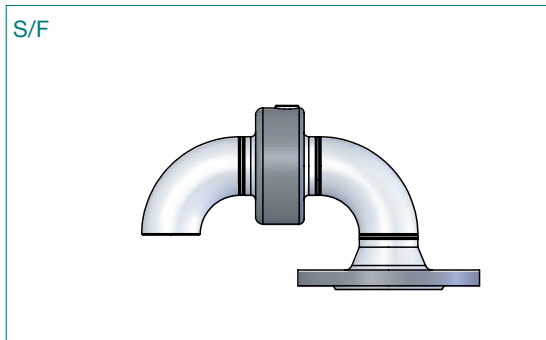
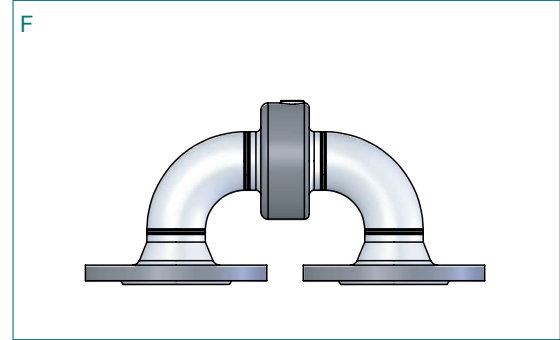
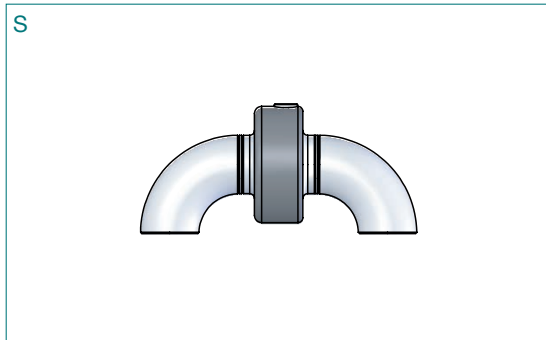

- N Nippel
nipple
- M Muffe
sleeve
- F Flansch DIN ANSI SAE
flange
- S Schweißende
welded

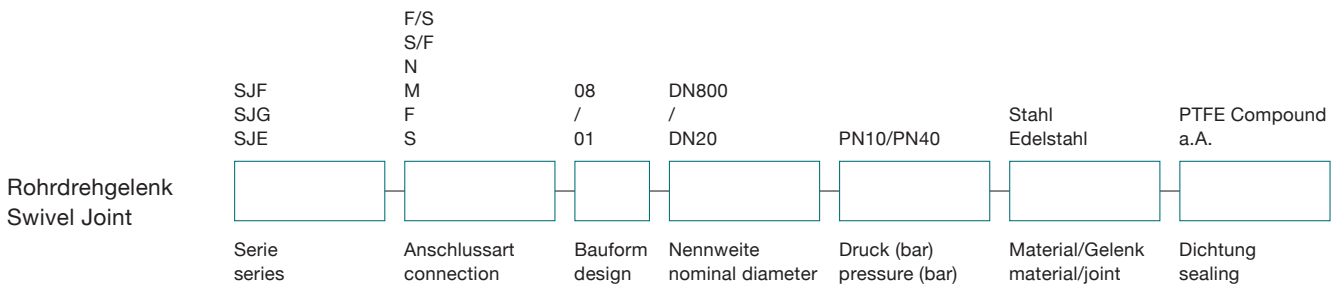

Bestellbeispiele
Ordering examples

SJF-F-03-DN100-PN16-PTFE-42CrMo4-nitriert

SJG-M-01-DN20-PTFE-1.4571

SJE-F-01-DN125-PN6-PTFE-1.4571

Allgemeine Information

General information

Anwendung / konstruktive Möglichkeiten

Ganymed®-Rohrdrehgelenke finden überall dort Verwendung, wo flüssige oder gasförmige Medien zwischen zwei sich relativ bewegenden Punkten zu transportieren sind. Ihre, in allen Ebenen um 360° gegebene Drehbarkeit, ihre besonders leichte Handhabung, ihre absolute Betriebssicherheit und eine sehr hohe Standzeit, ermöglichen den Einsatz an Stellen, an denen Schläuche den betrieblichen Anforderungen nicht mehr genügen.

Beispiele für Einsatzgebiete

- Schwenkende Rohrleitungen
- Klärbeckenräumer
- Verfahrbare Anlagenteile

Ganymed®-Rohrdrehgelenke sind in zwei Gruppen aufgeteilt:

- mit, im Rohrdrehgelenkkopf, integrierten Anschlüssen Serie: SJD, SJC, SJK, SJI
- mit, am Rohrdrehgelenkkopf, angeschweißten Anschlüssen Serie: SJF, SJG, SJE

Gesamtübersicht siehe Seite 4

Rohrdrehgelenke, die von der Standardausführung abweichen, werden als Sonderkonstruktion gefertigt und speziell für die Kundenanforderungen angepasst, z. B.

- höhere Betriebsdruck
- andere Anschlussarten
- molchbare Ausführung
- Sauerstoffbetrieb
- giftige Medien
- hohe und tiefe Temperaturen

Drehbarkeit

Die Drehbarkeit von Ganymed®-Rohrdrehgelenken wird über kugellagerähnlich angebrachte Kugelführungsbahnen erreicht.

Zur Sicherung der Kugeln und gegen Eindringen von Verschmutzungen in die Lagerung werden Spezialverschlussstopfen verwendet.

Werkstoff

Ganymed®-Rohrdrehgelenke sind standardmäßig aus den Werkstoffen: 1.7225 (42CrMo4) oder 1.4571 (X6CrNiMoTi17-12-2).

Belastungen (statisch)

Ganymed®-Rohrdrehgelenke sind für Schwenkbewegung konstruiert.

Sie nehmen, zusätzlich zur Innendruckbelastung, äußere Radial-Axialkräfte und Biegemomente auf. Die gesamte zulässige Belastung eines Gelenks hängt von vielen, betriebsbedingten Faktoren ab. Aus diesem Grunde ist die zulässige Belastung nur bei genauer Kenntnis des Einzelfalles festzustellen. Bei Angabe der genauen Betriebsbedingungen stehen wir gerne zur Verfügung, um ein geeignetes Ganymed®-Rohrdrehgelenk empfehlen zu können.

Use / constructive possibilities

Ganymed®-Swivel Joints can be used anywhere to transport fluid or gaseous media between two relatively movable points. It's 360° turning capacity in all levels, easy handling, absolute operational reliability and very long service life enable its use in places where tubes do not comply with operational requirements.

Example for fields of use

- Swiveling pipelines
- Clarifier scrapers
- Mobile installation components

Ganymed®-Swivel Joints can be divided into two groups:

- with integrated connections in the swivel joint series: SJD, SJC, SJK; SJI
- with connections welded on the swivel joint series: SJF, SJG, SJE

For a complete overview see page 4

For overview of the standard types we also manufacture specially constructed swivel joints to suit the customer's special requirements like e.g.:

- higher operational pressure
- other types of connections
- cleanable with go-devil
- oxygen operations
- toxic media
- higher of lower operational temperatures

Turning capacity

The turning capacity of Ganymed®-Swivel Joints is accomplished through built-in ball guiding tracks similar to ball bearings.

To secure the balls and prevent pollution from penetrating the bearing special sealing plugs are used.

Material

Standard Ganymed®-Swivel Joints are made of following material: 1.7225 (42CrMo4) or 1.4571 (X6CrNiMoTi17-12-2).

Static load

Ganymed®-Swivel Joints are constructed for swiveling motions.

In addition to stress through internal pressure they absorb external radial axial forces and bending movements. The maximum permissible load of a joint depends on many operational factors. For this reason the permissible load can only be determined after precise evaluation of the operational circumstances in each separate case. If you quote the precise operational conditions we will gladly recommend a suitable Ganymed®-Swivel Joint for your special purpose.

Allgemeine Information

General information

Abdichtung

Ganymed®-Rohrdrehgelenke sind mit einer axialwirkenden Medium-Dichtung ausgestattet, die aus PTFE-Compound hergestellt ist. Um die Dichtigkeit im niedrigen Druckbereich wie auch bei Vakuum zu gewährleisten, wird die Dichtung durch eine Edelstahlfeder vorgespannt. Durch die hervorragenden Eigenschaften des Dichtungswerkstoffes ist die Dichtung praktisch für alle Medien verwendbar bei geringem Reibmoment.

Um die Lagerung des Gelenkes vor äußerem Schmutz zu schützen, wird ein Schmutzabstreifer eingesetzt, der bei Bedarf mit einer äußeren Radialdichtung ausgetauscht werden kann. Damit ist das Gelenk hermetisch abgedichtet und kann somit für Einsatzfälle, wo Gelenke von einem Medium umspült sind, verwendet werden.

Schmierung

Ganymed®-Rohrdrehgelenke sind mit vollsynthetischen Spezialschmierstoffen, die jeweils den Betriebsbedingungen angepasst sind, auf Lebensdauer geschmiert.

Eine Nachschmiermöglichkeit ist deshalb nicht vorgesehen.

Sollte dennoch eine Möglichkeit des Nachschmierens gewünscht werden, ist diese auf Anforderung möglich. Hierbei ist unbedingt zu beachten, dass nur spezifisch festgelegte Schmierstoffe verwendet werden dürfen.

Für diesen Fall halten wir die Schmierstoffe lagermäßig vor.

Korrosionsschutz

Alle Ganymed®-Rohrdrehgelenke von Werkstoff 1.7225 (42CrMo4) sind durch Gasnitrieren weitestgehend gegen Korrosion geschützt. Für aggressive Medien steht Edelstahl (1.4571 / X6CrNiMoTi17-12-2) zur Verfügung.

Toleranzen: 3mm pro Schweißnaht.

Sealing

Ganymed®-Swivel Joints are fitted with an axial working medium seal made of a PTFE compound. To guarantee the seal in low pressure ranges as well as in vacuum the seal is pre-stretched by a stainless steel spring. Through the excellent properties of the sealing material the seal is suitable for practically all media with low friction moment.

To protect the bearing of the joint against outside pollution a dirt stripper is used, or, if necessary, it can be replaced by an outside radial seal. In this way the joints is hermetically sealed and can be used in places where the joint is in the medium.

Lubrication

Ganymed®-Swivel Joints are lubricated with special synthetic lubricants to suit the indicated operational conditions and to last the whole service life. That's why there is no possibility to lubricate.

If the possibility of relubrication is required, this is possible on request. Please note that only specifically determined lubricants should be used. We have lubricants on stock for this purpose.

Corrosion prevention

All Ganymed®-Swivel Joints from material 1.7225 (42CrMo4) are gasnitrided to prevent corrosion. For aggressive medias is stainless steel (1.4571 / X6CrNiMoTi17-12-2) available.

Tolerances: 3mm per weld.

Konstruktion / Funktion



Abb. kann vom Original abweichen!
Picture may differ from original!



Abb. kann vom Original abweichen!
Picture may differ from original!

Gelenk mit einer Kugelführungsbahn

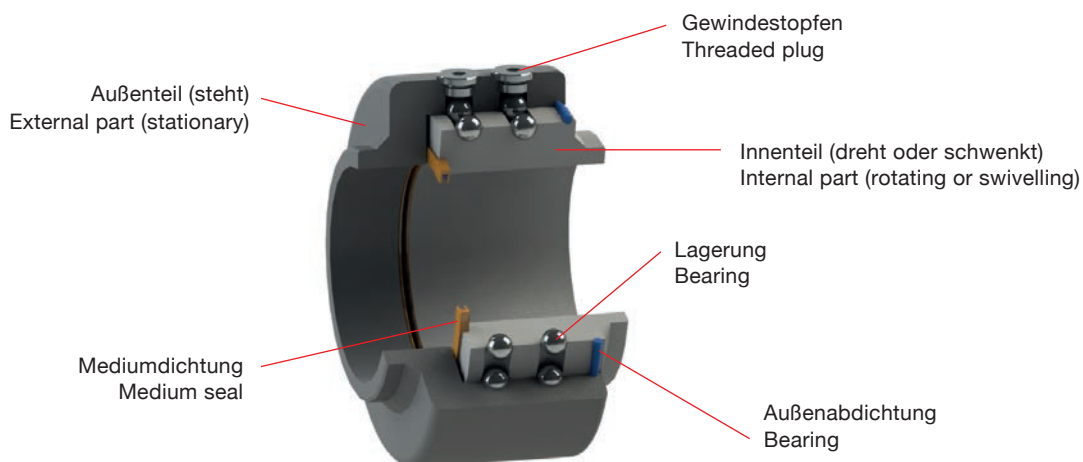
Joints with one ballgroove

Betriebsbedingungen:

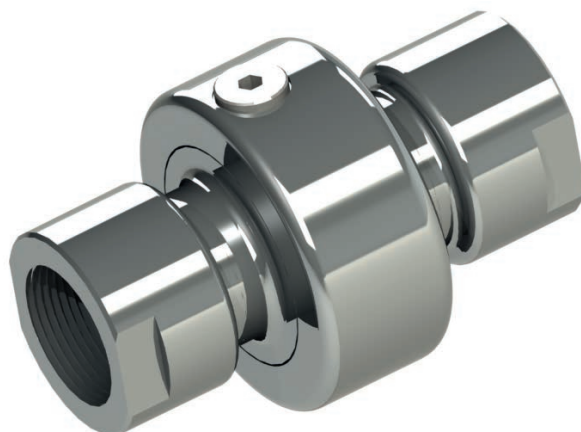
Medien	Wasser, Luft/Vakuum, Dampf, Hydrauliköl, Kraftstoff/Gas	
Max. Druck	Stahl	100 bar
	Edelstahl	40 bar
Max. Temperatur		200 °C
Min. Temperatur	Stahl	-20 °C
	Edelstahl	-50 °C
Max. Drehzahl		< 1 1/min
Größen	DN 20 - 100 (3/4" - 4")	

Operating data:

Media	water, air/vacuum, steam, hydraulic oil, gasoline/gas	
Max. pressure	steel	100 bar
	stainless steel	40 bar
Max. temperature		200 °C
Min. temperature	steel	-20 °C
	stainless steel	-50 °C
Max. speed		< 1 rpm
Sizes	DN 20 - 100 (3/4" - 4")	

- Stahl (42CrMo4) oder Edelstahl (1.4571)
- PTFE-Compound-Dichtung
- kugellagerähnliche Kugelführungsbahn
- Schwenkbewegung, Drehbewegungen bei geringen Drehzahlen

- steel (42CrMo4) or stainless steel (1.4571)
- PTFE-Compound-seal
- built-in ball guiding track similar to ball bearings
- swiveling, rotating movements with low speed

Die Betriebsparameter stehen in Relation zueinander. Daher dürfen die Rohrdrehgelenke bei der Kombination von Betriebsdaten im Maximalbereich nicht ohne Rücksprache mit HAAG + ZEISSLER eingesetzt werden.

The operating parameters are interrelated. Therefore, the swivel joints may not be used with a combination of operating data close to the maximum without first consulting HAAG + ZEISSLER.

Typ SJF
Type SJF



Abb. kann vom Original abweichen!
Picture may differ from original!

Abmessungen (mm) Stahl und Edelstahl Dimensions (mm) steel and stainless steel						
DN	Ø D	Ø d1	Ø di	B	C	G (kg)
20	72	26,9	21,2	55	9	1,10
25	78	33,7	26,9	60	10	1,35
32	88	42,4	35,2	60	10	1,70
40	96	48,3	36,9	60	10	1,80
50	118	60,3	48,5	70	12	3,10
65	133	73,0 / 76,1	62,6	75	15	3,70
80	139	88,9	74,4	75	15	3,70
100	164	114,3	102,3	75	15	4,70

Belastung (statisch) load (static)							
Werkstoff 1.7225 Material 1.7225				Werkstoff 1.4571 Material 1.4571			Reibmoment Friction torque
DN	p max bar	Mb (Nm) p=1 bar	Mb (Nm) p = 40 bar	p max bar	Mb (Nm) p=1 bar	Mb (Nm) p = 25 bar	Mr (Nm) p = 0
20	100,0	300,0	250,0	40,0	95,0	70,0	3,0
25	100,0	400,0	350,0	40,0	130,0	80,0	5,0
32	100,0	600,0	500,0	40,0	185,0	110,0	10,0
40	100,0	750,0	600,0	40,0	235,0	125,0	15,0
50	100,0	1500,0	1200,0	40,0	460,0	270,0	20,0
65	100,0	2000,0	1500,0	40,0	650,0	280,0	25,0
80	100,0	2350,0	1650,0	40,0	725,0	285,0	30,0
100	100,0	3500,0	2300,0	40,0	1000,0	300,0	35,0

Bitte beachten: die angegebenen Belastungen sind statische Werte. Faktoren wie pulsierender Druck, zusätzliche Axial- bzw. Radialkräfte beeinflussen die Belastbarkeit des Gelenks. Die angegebenen Reibmomente sind nur als Richtwert zu betrachten. Abweichungen sind möglich.

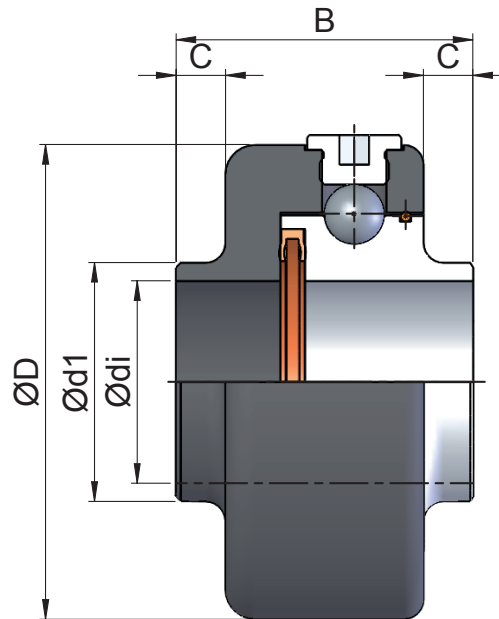
Please note: The loads indicated are static values. Factors such as pulsating pressure, additional axial and / radial forces influence the load capacity of the joint. The specified friction torques are only to be regarded as a guideline. Deviations are possible.

Typ SJF-F
Type SJF-F

Abmessungen (mm) Stahl Dimensions (mm) steel								
DN	Flansche DIN 2633 Flanges DIN 2633				Flansche DIN 2635 Flanges DIN 2635			
	L0	L1	L2	L3	L0	L1	L2	L3
20	137	111	124	66	141	111	126	68
25	142	116	129	66	146	116	131	68
32	146	130	138	75	150	130	140	77
40	150	142	146	83	156	142	149	86
50	166	178	172	99	172	178	175	102
65	171	209	190	112	185	209	197	119
80	181	233	207	129	197	233	215	137
100	185	284	234,5	156,5	211	284	247,5	169,5

Abmessungen (mm) Edelstahl Dimensions (mm) stainless steel								
DN	Flansche DIN 2633 Flanges DIN 2633				Flansche DIN 2635 Flanges DIN 2635			
	L0	L1	L2	L3	L0	L1	L2	L3
20	137	119	128	70	141	119	130	72
25	142	142	142	79	146	142	144	81
32	146	162	154	91	150	162	156	93
40	150	180	165	102	156	180	168	105
50	166	228	197	124	172	228	200	127
65	171	271	221	143	185	271	228	150
80	181	309	245	167	197	309	253	175
100	185	385	285	207	211	385	298	220

Andere Flanschanschlüsse und Baumaße auf Anfrage
Other flangeconnections and dimensions on request.

Gewichte (kg) Stahl Weights (kg) steel																
DN	Flansche DIN 2633 Flanges DIN 2633								Flansche DIN 2635 Flanges DIN 2635							
	Bauformen Models								Bauformen Models							
	01	02	03	04	05	06	07	08	01	02	03	04	05	06	07	08
20	3,1	3,2	3,3	4,3	4,4	4,5	5,5	5,6	3,3	3,4	3,5	4,5	4,6	4,7	5,7	5,8
25	3,6	3,7	3,8	5,1	5,2	5,3	6,6	6,7	4,0	4,1	4,2	5,5	5,6	5,7	7,0	7,1
32	6,6	6,8	7,0	8,5	8,7	10,4	10,4	12,1	5,5	5,7	5,9	7,4	7,6	7,8	9,3	9,5
40	5,8	6,1	6,3	7,9	8,1	8,7	10,0	10,5	6,1	6,4	6,7	8,2	8,5	8,5	10,3	10,3
50	8,2	9,0	9,5	12,1	12,6	13,5	15,7	16,6	8,4	8,9	9,4	12,0	12,5	12,7	15,6	15,8
65	10,1	11,2	12,3	14,9	16,0	17,3	19,7	21,0	11,1	12,2	13,3	15,9	17,0	18,1	20,7	21,8
80	11,5	13,6	15,1	17,3	18,8	21,3	22,5	25,0	13,8	15,3	16,8	19,0	20,5	22,5	24,2	26,2
100	14,0	16,8	19,6	21,5	24,3	27,2	29,0	31,9	17,7	20,5	23,3	25,2	28,0	30,8	32,7	35,5

Gewichte für Edelstahl ausführung können abweichen.
ANSI- und SAE-Flansche lieferbar.

Weights for stainless steel may be different.
ANSI- and SAE-flanges available.

Flanschanschluss
Flange connection



Abb. kann vom Original abweichen!
Picture may differ from original!

Type SJF-S

Abmessungen (mm) Stahl Dimensions (mm) steel						
DN	L0	L1	L2	L3	Ø d	s
20	161	111	136,0	25,0	26,9	2,9
25	166	116	141,0	25,0	33,7	3,2
32	166	130	148,0	32,0	42,4	3,6
40	166	142	154,0	38,0	48,3	3,6
50	176	178	177,0	51,0	60,3	4,0
65	181	207	194,0	63,0	76,1	5,6
80	181	233	207,0	76,0	88,9	5,6
100	181	284	232,5	101,5	114,3	6,3

Abmessungen (mm) Edelstahl Dimensions (mm) stainless steel						
DN	L0	L1	L2	L3	Ø d	s
20	161	119	140	29	26,9	2,3
25	166	142	154	38	33,7	2,6
32	166	162	164	48	42,4	2,6
40	166	180	173	57	48,3	2,6
50	176	228	202	76	60,3	2,9
65	181	271	226	95	76,1	2,9
80	181	309	245	114	88,9	3,2
100	181	385	283	152	114,3	3,6

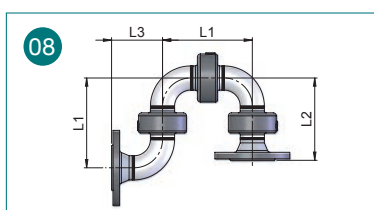
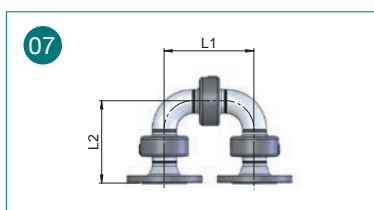
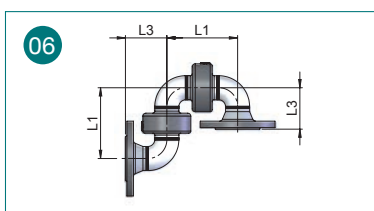
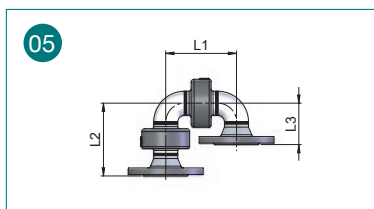
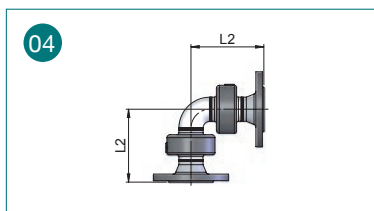
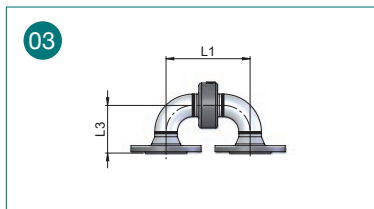
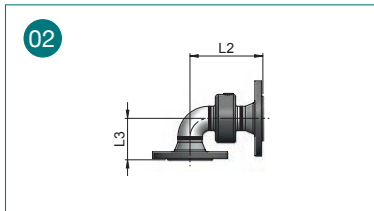
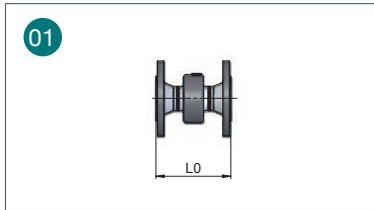
Andere Baumaße auf Anfrage
Other dimensions on request.

Gewichte (kg) Stahl Weights (kg) steel								
DN	Bauformen Models							
	01	02	03	04	05	06	07	08
20	1,3	1,4	1,5	2,5	2,6	2,7	3,7	3,8
25	1,6	1,7	1,8	3,1	3,2	3,3	4,6	4,7
32	1,9	2,1	2,3	3,8	4,0	4,2	5,7	5,9
40	2,2	2,5	2,8	4,3	4,6	4,9	6,4	6,7
50	3,9	4,4	4,9	7,5	8,0	8,9	11,1	12,0
65	5,1	5,6	6,2	9,3	9,9	11,2	13,6	14,9
80	5,3	6,2	7,7	9,9	11,4	13,3	15,1	17,0
100	6,7	9,5	12,3	14,2	17,0	20,8	21,7	25,5

Gewichte für Edelstahlausführung können abweichen.
Weights for stainless steel may be different.

Schweißfase
Welding end



Abb. kann vom Original abweichen!
Picture may differ from original!

Typ SJF-M
Type SJF-M

Abmessungen (mm) Stahl Dimensions (mm) steel							
DN	L0	L1	L2	L3	Ø d _g	i	SW
20	125	111	118	60	G 3/4"	22	32
25	140	116	128	65	G 1"	26	41
32	146	130	138	75	G 1 1/4"	28	50
40	156	142	149	86	G 1 1/2"	30	60
50	176	178	177	104	G 2"	32	70
65	201	209	205	127	G 2 1/2"	42	85
80	221	233	227	149	G 3"	48	100
100	241	284	262,5	184,5	G 4"	58	125

Abmessungen (mm) Edelstahl Dimensions (mm) stainless steel							
DN	L0	L1	L2	L3	Ø d _g	i	SW
20	125	119	122	64	G 3/4"	22	32
25	140	142	141	78	G 1"	26	41
32	146	162	154	91	G 1 1/4"	28	50
40	156	180	168	105	G 1 1/2"	30	60
50	176	228	202	129	G 2"	32	70
65	201	271	236	158	G 2 1/2"	42	85
80	221	309	265	187	G 3"	48	100
100	241	385	313	235	G 4"	58	125

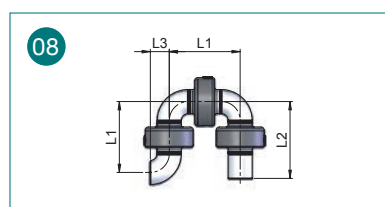
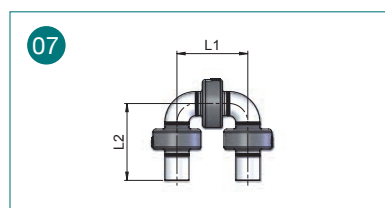
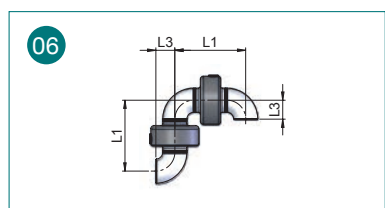
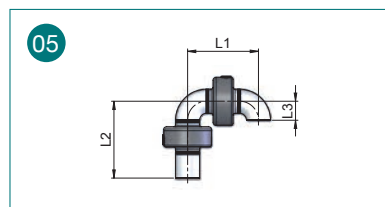
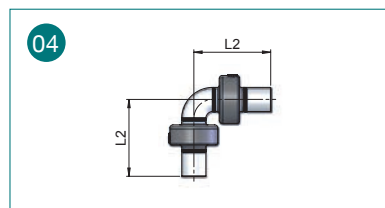
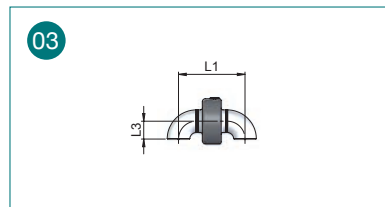
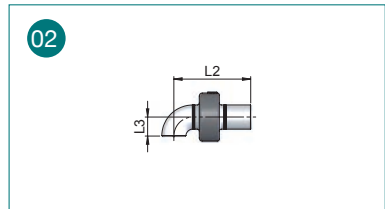
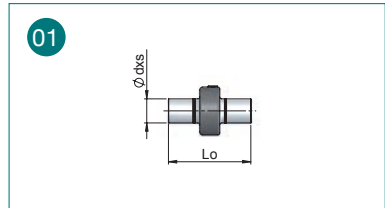
Andere Baumaße auf Anfrage
Other dimensions on request.

Gewichte (kg) Stahl Weights (kg) steel								
DN	BaufORMen Models							
	01	02	03	04	05	06	07	08
20	1,3	1,4	1,5	2,5	2,6	2,7	3,7	3,8
25	1,8	1,9	2,0	3,3	3,4	3,5	4,8	4,9
32	2,4	2,6	2,8	4,3	4,5	4,8	6,2	6,5
40	3,0	3,3	3,6	5,1	5,4	5,7	7,2	7,5
50	4,7	5,1	5,7	8,2	8,8	9,4	11,9	12,5
65	6,5	7,6	8,6	11,3	12,3	13,8	16,0	17,5
80	7,6	9,4	10,9	13,1	14,6	16,7	18,3	20,4
100	10,9	14,3	17,0	19,0	21,7	24,9	26,4	29,6

Gewichte für Edelstahlausführung können abweichen.
NTP-Gewinde lieferbar

Weights for stainless steel may be different.
NTP-thread available

Innengewinde
Female thread



Abb. kann vom Original abweichen!
Picture may differ from original!

Typ SJF-N
Type SJF-N

Abmessungen (mm) Stahl Dimensions (mm) steel							
DN	L0	L1	L2	L3	Ø d _g	i	SW
20	115	111	113	55	G 3/4	16	32
25	130	116	123	60	G 1	18	41
32	136	130	133	70	G 1 1/4	20	50
40	146	142	144	81	G 1 1/2	22	60
50	166	178	172	99	G 2	24	70
65	191	209	200	122	G 2 1/2	34	85
80	211	233	222	144	G 3	40	100
100	231	284	257,5	179,5	G 4	50	125

Abmessungen (mm) Edelstahl Dimensions (mm) stainless steel							
DN	L0	L1	L2	L3	Ø d _g	i	SW
20	115	119	117	59	G 3/4"	16	32
25	130	142	136	73	G 1"	18	41
32	136	162	149	86	G 1 1/4"	20	50
40	146	180	163	100	G 1 1/2"	22	60
50	166	228	197	124	G 2"	24	70
65	191	271	231	153	G 2 1/2"	34	85
80	211	309	260	182	G 3"	40	100
100	231	385	308	230	G 4"	50	125

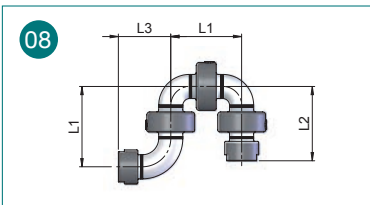
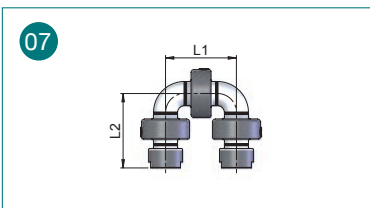
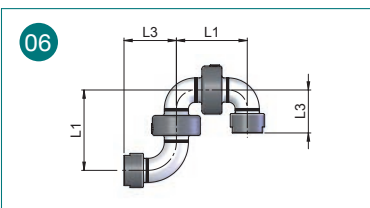
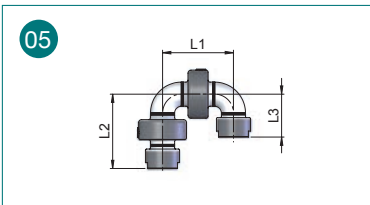
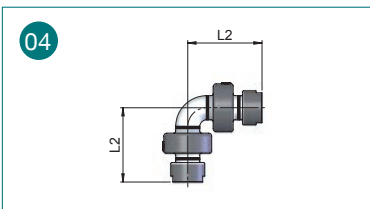
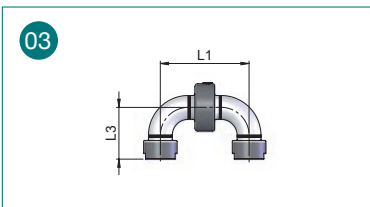
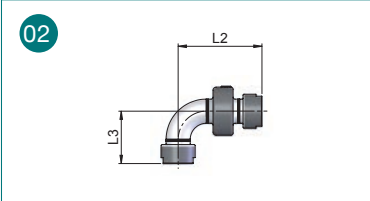
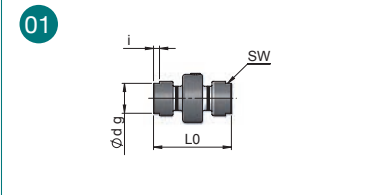
Andere Baumaße auf Anfrage
Other dimensions on request.

Gewichte (kg) Stahl Weights (kg) steel								
DN	BaufORMen Models							
	01	02	03	04	05	06	07	08
20	1,3	1,4	1,5	2,5	2,6	2,7	3,7	3,8
25	1,7	1,8	1,9	3,2	3,3	3,4	4,7	4,8
32	2,1	2,3	2,5	4,0	4,2	4,4	5,9	6,1
40	2,4	2,7	3,0	4,5	4,8	5,1	6,6	6,9
50	4,2	4,8	5,2	7,9	8,5	9,1	11,6	12,2
65	5,6	6,7	7,8	10,4	11,5	13,2	15,3	16,9
80	6,3	7,8	9,3	11,5	13,0	14,5	16,7	18,2
100	8,7	11,5	14,3	16,2	19,0	21,4	23,7	26,1

Gewichte für Edelstahlausführung können abweichen.
NTP-Gewinde lieferbar

Weights for stainless steel may be different.
NTP-thread available

Außengewinde
Male thread



Abb. kann vom Original abweichen!
Picture may differ from original!



Abb. kann vom Original abweichen!
Picture may differ from original!

Gelenk mit zwei Kugelführungsbahnen

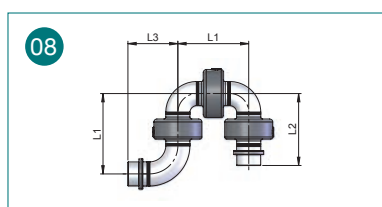
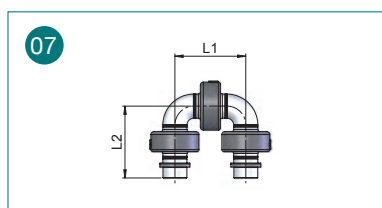
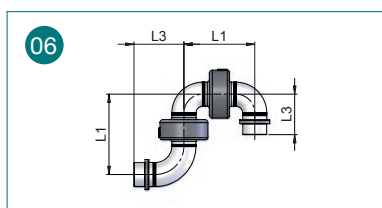
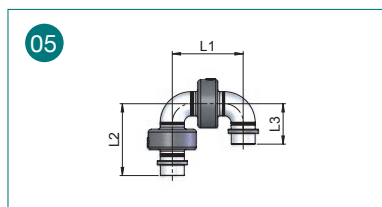
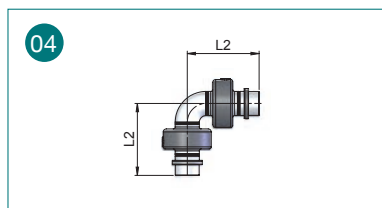
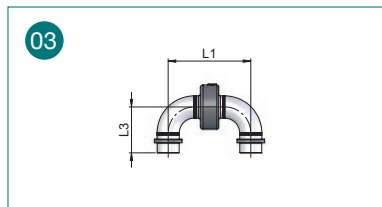
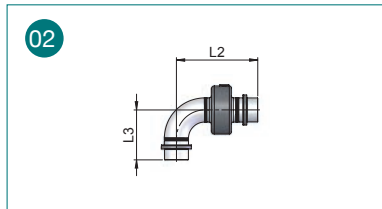
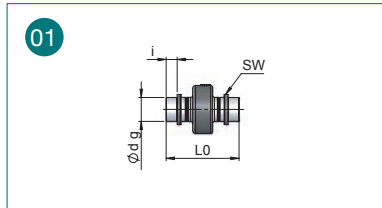
Joint with two ballgroove

Betriebsbedingungen:

Medien	Wasser, Luft/Vakuum, Dampf, Hydrauliköl, Kraftstoff/Gas	
Max. Druck	Stahl DN 20 - DN 50	350 bar
	Stahl DN 65 - DN 125	250 bar
	Stahl DN 150 - DN 300	100 bar
	Edelstahl DN 20 - DN 125	100 bar
	Edelstahl DN 150 - DN 300	40 bar
Max. Temperatur		200 °C
Min. Temperatur	Stahl	-20 °C
	Edelstahl	-50 °C
Max. Drehzahl		< 1 1/min
Größen	DN 20 - 300 (3/4" - 12")	

Operating data:

Media	water, air/vacuum, steam, hydraulic oil, gasoline/gas	
Max. pressure	steel DN 20 - DN 50	350 bar
	steel DN 65 - DN 125	250 bar
	steel DN 150 - DN 300	100 bar
	stainless steel DN 20 - DN 125	100 bar
	stainless steel DN 150 - DN 300	40 bar
Max. temperature		200 °C
Min. temperature	steel	-20 °C
	stainless steel	-50 °C
Max. speed		< 1 rpm
Sizes	DN 20 - 300 (3/4" - 12")	

- Stahl (42CrMo4) oder Edelstahl (1.4571)
- PTFE-Compound-Dichtung
- kugellagerähnliche Kugelführungsbahn
- Schwenkbewegung, Drehbewegungen bei geringen Drehzahlen

- steel (42CrMo4) or stainless steel (1.4571)
- PTFE-Compound-seal
- built-in ball guiding track similar to ball bearings
- swiveling, rotating movements with low speed

Die Betriebsparameter stehen in Relation zueinander. Daher dürfen die Rohrdrehgelenke bei der Kombination von Betriebsdaten im Maximalbereich nicht ohne Rücksprache mit HAAG + ZEISSLER eingesetzt werden.

The operating parameters are interrelated. Therefore, the swivel joints may not be used with a combination of operating data close to the maximum without first consulting HAAG + ZEISSLER.

Typ SJG
Type SJG



Abb. kann vom Original abweichen!
Picture may differ from original!

Abmessungen (mm) Stahl und Edelstahl Dimensions (mm) steel and stainless steel						
DN	Ø D	Ø d1	Ø di	B	C	G (kg)
20	72	26,9	18,0	90	12,5	1,7
25	78	33,7	23,0	90	12,5	2,2
32	88	42,4	31,2	90	12,5	2,7
40	104	48,3	36,9	90	12,5	3,2
50	118	60,3	48,5	100	13,5	4,7
65	133	73,0 / 76,1	59,0	110	13,5	6,6
80	139	88,9	73,7	110	13,5	6,9
100	175	114,3	97,1	110	14,5	10,5
125	218	141,3 / 139,7	122,3	140	17,5	19,8
150	250	168,3	150,0	155	22,5	25,6
200	330	219,1	198,7	180	22,5	55,0
250	375	273,0	250,4	185	22,5	63,0
300	455	323,9	301,0	195	25,0	99,0

Belastung (statisch) load (static)							
DN	Werkstoff 1.7225 Material 1.7225			Werkstoff 1.4571 Material 1.4571			Reibmoment Friction torque
	p max bar	Mb (Nm) p=1 bar	Mb (Nm) p = 40 bar	p max bar	Mb (Nm) p=1 bar	Mb (Nm) p = 40 bar	Mr (Nm) p = 0
20	350,0	550,0	500,0	100,0	200,0	160,0	3,0
25	350,0	750,0	675,0	100,0	275,0	200,0	5,0
32	350,0	1000,0	950,0	100,0	400,0	300,0	10,0
40	350,0	1500,0	1250,0	100,0	550,0	360,0	15,0
50	350,0	2700,0	2400,0	100,0	1000,0	700,0	20,0
65	250,0	3750,0	3250,0	100,0	1400,0	850,0	25,0
80	250,0	4250,0	3500,0	100,0	1600,0	900,0	30,0
100	250,0	7250,0	6000,0	100,0	2750,0	1250,0	35,0
125	250,0	15000,0	12500,0	100,0	5750,0	3000,0	50,0
150	100,0	20000,0	15750,0	40,0	7500,0	3250,0	85,0
200	100,0	47500,0	37500,0	40,0	17500,0	7750,0	250,0
250	100,0	75000,0	57500,0	40,0	27750,0	11000,0	350,0
300	100,0	115000,0	85000,0	40,0	42500,0	12500,0	400,0

Bitte beachten: die angegebenen Belastungen sind statische Werte. Faktoren wie pulsierender Druck, zusätzliche Axial- bzw. Radialkräfte beeinflussen die Belastbarkeit des Gelenks. Die angegebenen Reibmomente sind nur als Richtwert zu betrachten. Abweichungen sind möglich.

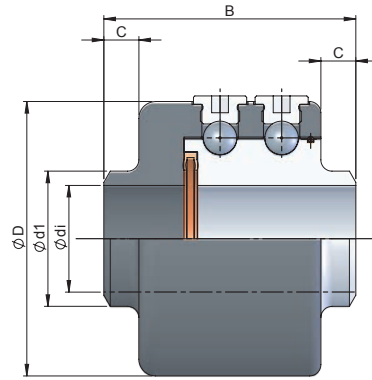
Please note: The loads indicated are static values. Factors such as pulsating pressure, additional axial and / radial forces influence the load capacity of the joint. The specified friction torques are only to be regarded as a guideline. Deviations are possible.

Typ SJG-F
Type SJG-F

Abmessungen (mm) Stahl Dimensions (mm) steel								
DN	Flansche DIN 2633 Flanges DIN 2633				Flansche DIN 2635 Flanges DIN 2635			
	L0	L1	L2	L3	L0	L1	L2	L3
20	172	146	159,0	66,0	176	146	161,0	68,0
25	172	146	159,0	66,0	176	146	161,0	68,0
32	176	160	168,0	75,0	180	160	170,0	77,0
40	180	172	176,0	83,0	186	172	179,0	86,0
50	196	208	202,0	99,0	202	208	205,0	102,0
65	206	244	225,0	112,0	220	244	232,0	119,0
80	216	268	242,0	129,0	232	268	250,0	137,0
100	220	319	269,5	156,5	246	319	282,5	169,5
125	256	400	328,0	185,0	282	400	341,0	198,0

Abmessungen (mm) Edelstahl Dimensions (mm) stainless steel								
DN	Flansche DIN 2633 Flanges DIN 2633				Flansche DIN 2635 Flanges DIN 2635			
	L0	L1	L2	L3	L0	L1	L2	L3
20	172	154	163	70	176	154	165	72
25	172	172	172	79	176	172	174	81
32	176	192	184	91	180	192	186	93
40	180	210	195	102	186	210	198	105
50	196	258	227	124	202	258	230	127
65	206	306	256	143	220	306	263	150
80	216	344	280	167	232	344	288	175
100	220	420	320	207	246	420	333	220
125	256	526	391	248	282	526	404	261

Andere Flanschanschlüsse und Baumaße auf Anfrage
Other flangeconnections and dimensions on request.

Gewichte (kg) Stahl Weights (kg) steel																
DN	Flansche DIN 2633 Flanges DIN 2633								Flansche DIN 2635 Flanges DIN 2635							
	Bauformen Models								Bauformen Models							
	01	02	03	04	05	06	07	08	01	02	03	04	05	06	07	08
20	3,5	3,6	3,7	5,3	5,4	6,3	7,1	8,0	3,7	3,8	3,9	5,5	5,6	5,7	7,3	7,4
25	4,5	4,6	4,7	6,8	6,9	7,1	9,1	9,3	4,8	4,7	5,0	7,1	7,2	7,3	9,4	9,5
32	6,1	6,3	6,5	9,0	9,2	9,4	11,9	12,1	6,5	6,7	6,9	9,4	9,6	9,8	12,3	12,5
40	6,9	7,2	7,5	10,4	10,7	10,9	13,9	14,1	7,8	8,1	8,3	11,3	11,5	11,8	14,7	15,0
50	10,5	10,8	11,3	15,5	16,0	17,1	20,7	21,8	10,3	10,8	11,3	15,5	16,0	16,4	20,7	21,1
65	13,3	14,5	15,6	21,1	22,2	23,9	28,8	30,5	14,0	15,1	16,1	21,7	22,7	23,8	29,3	30,4
80	15,0	16,5	18,0	23,4	24,9	27,1	31,8	34,0	16,5	18,0	19,5	24,9	26,4	27,9	33,3	34,8
100	19,5	22,3	25,1	32,8	35,5	38,2	46,1	48,7	23,5	26,3	29,0	36,8	39,5	42,3	50,0	52,8
125	32,4	39,1	45,8	58,9	65,5	72,2	85,4	92,0	38,0	44,7	51,3	64,5	71,1	77,8	90,9	97,6

Gewichte für Edelstahl Ausführung können abweichen.
ANSI- und SAE-Flansche lieferbar.

Weights for stainless steel may be different.
ANSI- and SAE-flanges available.

Flanschanschluss
Flange connection



Abb. kann vom Original abweichen!
Picture may differ from original!

Typ SJG-F
Type SJG-F

Abmessungen (mm) Stahl Dimensions (mm) steel												
DN	Flansche DIN 2632 Flanges DIN 2632				Flansche DIN 2633 Flanges DIN 2633				Flansche DIN 2635 Flanges DIN 2635			
	L0	L1*	L2*	L3*	L0	L1*	L2*	L3*	L0	L1*	L2*	L3*
150					271	466	368,5	210,5	311	466	388,5	230,5
200	310	592	451	268	310	592	451,0	268,0	362	592	477,0	294,0
250	327	699	550	362	331	699	515,0	327,0	401	699	550,0	362,0
300	337	811	574	376	357	811	584,0	386,0	431	811	621,0	423,0

* Kurze Bögen auf Anfrage
* Short elbows on request.

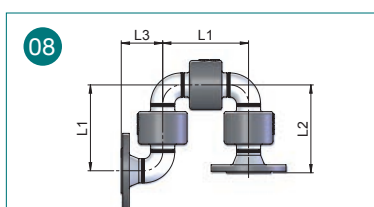
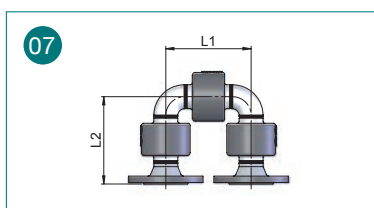
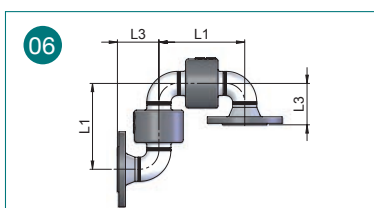
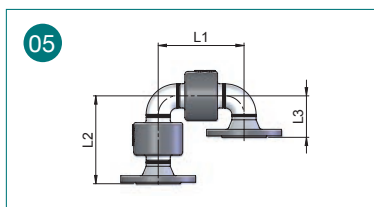
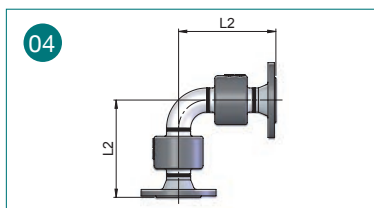
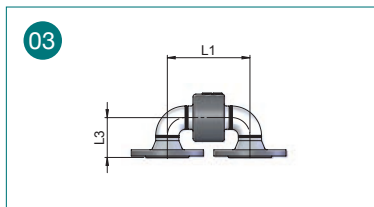
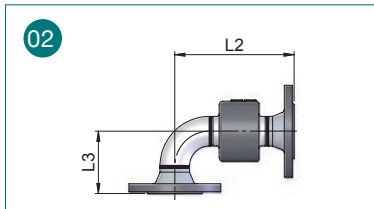
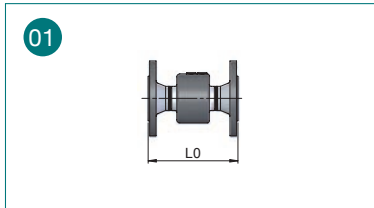
Abmessungen (mm) Edelstahl Dimensions (mm) stainless steel												
DN	Flansche DIN 2632 Flanges DIN 2632				Flansche DIN 2633 Flanges DIN 2633				Flansche DIN 2635 Flanges DIN 2635			
	L0	L1	L2	L3	L0	L1	L2	L3	L0	L1	L2	L3
150					271	618	444,5	286,5	311	618	464,5	306,5
200	310	796	553	370	310	796	553,0	370,0	362	796	579,0	396,0
250	327	953	640	452	331	953	642,0	454,0	401	953	677,0	489,0
300	337	1115	726	528	357	1115	736,0	538,0	431	1115	773,0	575,0

Andere Flanschschlüsse und Baumaße auf Anfrage
Other flangeconnections and dimensions on request.

Gewichte (kg) Stahl Weights (kg) steel												
DN	Flansche DIN 2632 Flanges DIN 2632				Flansche DIN 2633 Flanges DIN 2633				Flansche DIN 2635 Flanges DIN 2635			
	Baufornen Models				Baufornen Models				Baufornen Models			
	01	02	03		01	02	03		01	02	03	
150					41,1	45,5	50,0		49,2	53,6	58,1	
200	77,6	88,5	99,4		77,0	87,9	98,8		98,0	108,9	119,8	
250	92,4	108,9	125,4		94,2	110,7	127,2		132,8	149,3	165,8	
300	133,8	160,4	187,0		143,0	169,6	196,2		198,4	225,0	251,6	

Gewichte für Edelstahlausführung können abweichen.
ANSI- und SAE-Flansche lieferbar.

Weights for stainless steel may be different.
ANSI- and SAE-flanges available.

Flanschsanschluss
Flange connection



Abb. kann vom Original abweichen!
Picture may differ from original!

Typ SJG-S
Type SJG-S

Abmessungen (mm) Stahl Dimensions (mm) steel								
DN	L0	L1	L2	L3	Ø d	s		
						PN140	PN 250	PN 350
20	196	146	171,0	25,0	26,9	2,9	4,0	a. A.
25	196	146	171,0	25,0	33,7	3,2	4,5	a. A.
32	196	160	178,0	32,0	42,4	3,6	5,0	a. A.
40	196	172	184,0	38,0	48,3	3,6	5,0	a. A.
50	206	208	207,0	51,0	60,3	4,0	5,6	a. A.
65	216	242	229,0	63,0	76,1	5,6	7,1	a. A.
80	216	268	242,0	76,0	88,9	5,6	8,0	a. A.
100	216	319	267,5	101,5	114,3	6,3	8,8	a. A.
125	246	400	323,0	127,0	139,7	7,1	10,0	a. A.

Abmessungen (mm) Edelstahl Dimensions (mm) stainless steel						
DN	L0	L1	L2	L3	Ø d	S
20	196	154	175	29	26,9	2,3
25	196	172	184	38	33,7	2,6
32	196	192	194	48	42,4	2,6
40	196	210	203	57	48,3	2,6
50	206	258	232	76	60,3	2,9
65	216	306	261	95	76,1	2,9
80	216	344	280	114	88,9	3,2
100	216	420	318	152	114,3	3,6
125	246	526	386	190	139,7	4,0

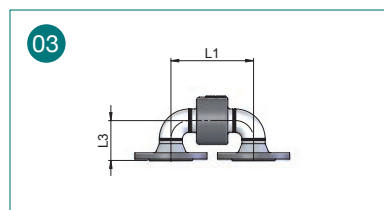
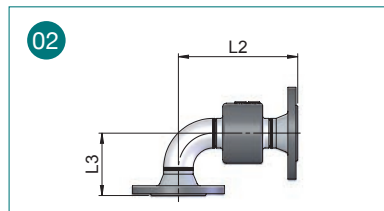
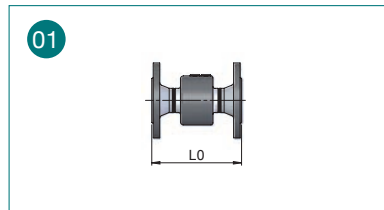
Andere Baumaße auf Anfrage
Other dimensions on request.

Gewichte (kg) Stahl Weights (kg) steel																
DN	PN 140								PN 250							
	Baupformen Models								Baupformen Models							
	01	02	03	04	05	06	07	08	01	02	03	04	05	06	07	08
20	1,9	2,0	2,1	3,7	3,8	3,9	5,5	5,6	1,9	2,0	2,1	3,7	3,8	3,9	5,5	5,6
25	2,4	2,5	2,6	4,7	4,8	4,9	7,0	7,1	2,4	2,5	2,6	4,7	4,8	4,9	7,0	7,1
32	3,1	3,3	3,5	6,0	6,2	6,4	8,9	9,1	3,1	3,4	3,7	6,1	6,4	6,7	9,1	9,4
40	3,6	3,9	4,2	7,1	7,4	7,7	10,6	10,9	3,6	4,0	4,4	7,2	7,6	8,0	10,8	11,2
50	5,3	5,8	6,3	10,5	11,0	11,5	15,7	16,2	5,3	6,0	6,7	10,7	11,4	12,3	16,1	17,0
65	7,2	9,3	10,4	15,9	17,0	19,1	23,6	25,7	7,4	8,7	10,0	15,3	16,6	17,9	23,2	24,5
80	8,1	9,6	11,1	16,5	18,0	19,5	14,9	26,4	8,1	10,2	12,3	17,1	19,2	21,3	26,1	28,2
100	11,7	14,5	17,3	25,0	27,8	30,6	38,3	41,1	12,1	15,9	19,7	26,4	30,2	34,8	40,7	45,3
125	21,8	28,5	35,2	48,3	55,0	61,7	74,8	81,5	22,0	28,7	35,4	48,5	55,2	61,9	75,0	81,4

Gewichte für Edelstahl Ausführung können abweichen.
Weights for stainless steel may be different.

Schweißfase
Welding end



Abb. kann vom Original abweichen!
Picture may differ from original!

Typ SJG-M
Type SJG-M

Abmessungen (mm) Stahl Dimensions (mm) steel							
DN	L0	L1	L2	L3	Ø d _g	i	SW
20	160	146	153,0	60,0	G 3/4"	22	32
25	170	146	158,0	65,0	G 1"	26	41
32	176	160	168,0	75,0	G 1 1/4"	28	50
40	186	172	179,0	86,0	G 1 1/2"	30	60
50	206	208	207,0	104,0	G 2"	32	70
65	236	244	240,0	127,0	G 2 1/2"	42	85
80	256	268	262,0	149,0	G 3"	48	100
100	276	319	297,5	184,5	G 4"	58	125

Abmessungen (mm) Edelstahl Dimensions (mm) stainless steel							
DN	L0	L1	L2	L3	Ø d _g	i	SW
20	160	154	157	64	G 3/4"	22	32
25	170	172	171	78	G 1"	26	41
32	176	192	184	91	G 1 1/4"	28	50
40	186	210	198	105	G 1 1/2"	30	60
50	206	258	232	129	G 2"	32	70
65	236	306	271	158	G 2 1/2"	42	85
80	256	344	300	187	G 3"	48	100
100	276	420	348	235	G 4"	58	125

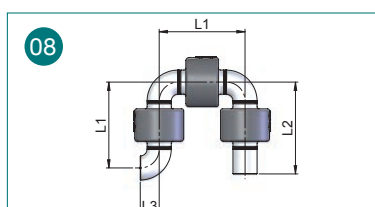
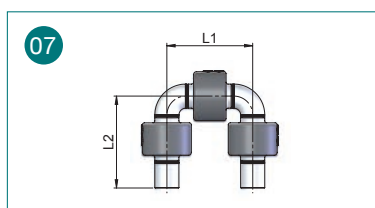
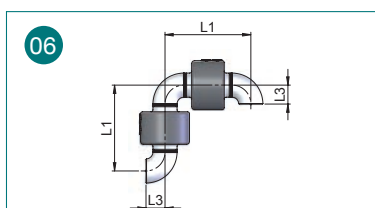
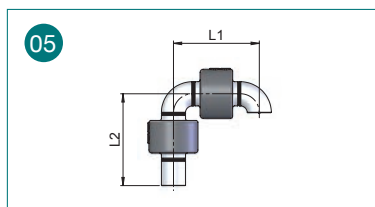
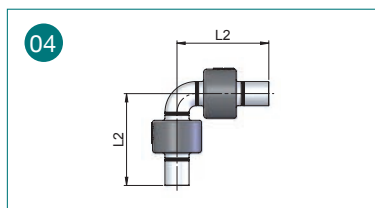
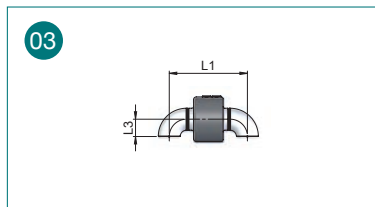
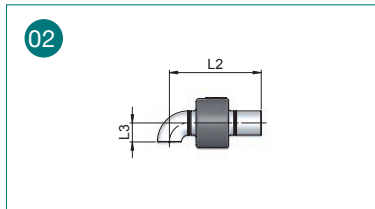
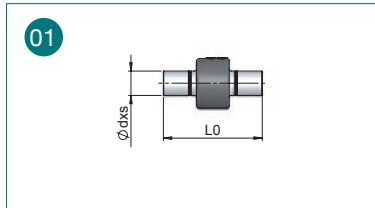
Andere Baumaße auf Anfrage
Other dimensions on request.

Gewichte (kg) Stahl Weights (kg) steel								
DN	Bauformen Models							
	01	02	03	04	05	06	07	08
20	1,9	2,0	2,1	3,7	3,8	3,9	5,4	5,5
25	2,6	2,7	2,8	4,9	5,0	5,1	7,2	7,3
32	3,3	3,5	3,7	6,2	6,4	6,6	9,1	9,3
40	4,4	4,7	5,0	7,9	8,2	8,5	11,4	11,7
50	6,1	6,6	7,1	11,3	11,8	12,3	16,5	17,0
65	9,0	10,1	11,2	16,7	17,8	18,9	24,4	25,5
80	10,5	12,0	13,5	18,9	20,4	21,9	27,3	28,8
100	16,9	19,7	22,5	30,2	33,0	35,8	43,5	46,3

Gewichte für Edelstahlausführung können abweichen.
NTP-Gewinde lieferbar

Weights for stainless steel may be different.
NTP-thread available

Innengewinde
Female thread



Abb. kann vom Original abweichen!
Picture may differ from original!

Typ SJG-N
Type SJG-N

Abmessungen (mm) Stahl Dimensions (mm) steel							
DN	L0	L1	L2	L3	Ø d _g	i	SW
20	150	146	148,0	55,0	G 3/4"	16	32
25	160	146	153,0	60,0	G 1"	18	41
32	166	160	163,0	70,0	G 1 1/4"	20	50
40	176	172	174,0	81,0	G 1 1/2"	22	60
50	196	208	202,0	99,0	G 2"	24	70
65	226	244	235,0	112,0	G 2 1/2"	34	85
80	246	268	257,0	144,0	G 3"	40	100
100	266	319	292,5	179,5	G 4"	50	125

Abmessungen (mm) Edelstahl Dimensions (mm) stainless steel							
DN	L0	L1	L2	L3	Ø d _g	i	SW
20	150	154	152	59	G 3/4"	16	32
25	160	172	166	73	G 1"	18	41
32	166	192	179	86	G 1 1/4"	20	50
40	176	210	193	100	G 1 1/2"	22	60
50	196	258	227	124	G 2"	24	70
65	226	306	266	153	G 2 1/2"	34	85
80	246	344	295	182	G 3"	40	100
100	266	420	343	230	G 4"	50	125

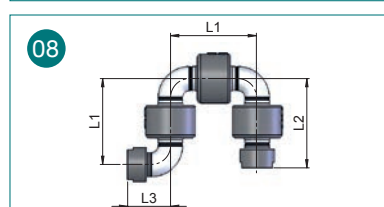
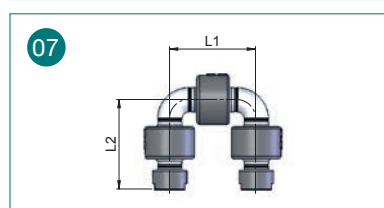
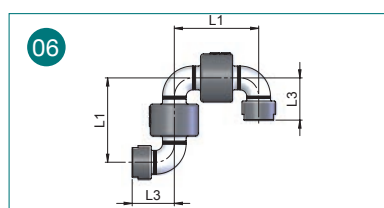
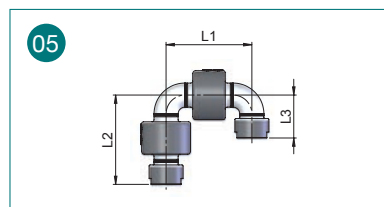
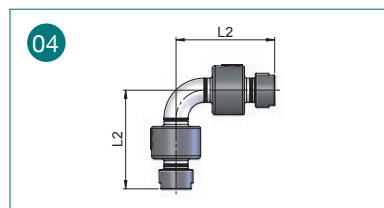
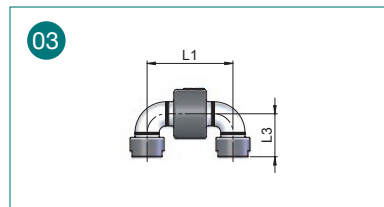
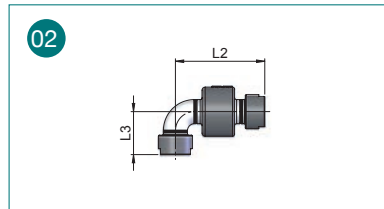
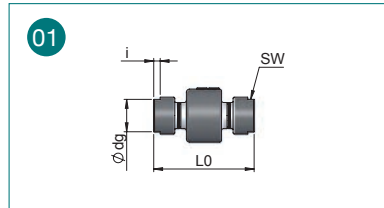
Andere Baumaße auf Anfrage
Other dimensions on request.

Gewichte (kg) Stahl Weights (kg) steel								
DN	BaufORMen Models							
	01	02	03	04	05	06	07	08
20	1,9	2,0	2,1	3,7	3,8	3,9	5,5	5,6
25	2,5	2,6	2,7	4,8	4,9	5,0	7,1	7,2
32	3,1	3,3	3,5	6,0	6,2	6,4	8,9	9,1
40	3,8	4,1	4,4	7,3	7,6	7,9	10,8	11,1
50	5,6	6,1	6,6	10,8	11,3	11,8	16,0	16,5
65	7,9	9,0	10,1	15,6	16,7	17,8	23,3	24,4
80	9,5	11,0	12,5	17,9	19,4	20,9	26,3	27,8
100	14,9	17,7	20,5	28,2	31,0	33,8	41,5	52,0

Gewichte für EdelstahlAusführung können abweichen.
NTP-Gewinde lieferbar

Weights for stainless steel may be different.
NTP-thread available

Außengewinde
Male thread



Abb. kann vom Original abweichen!
Picture may differ from original!



Abb. kann vom Original abweichen!
Picture may differ from original!

Gelenk mit zwei Kugelführungsbahnen

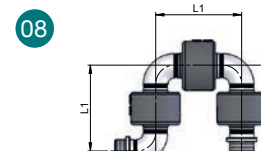
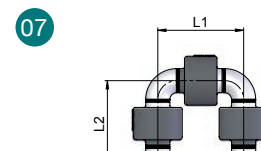
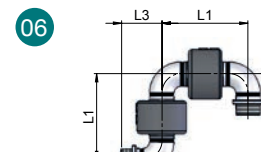
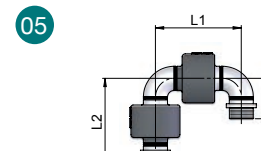
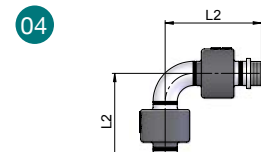
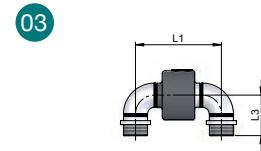
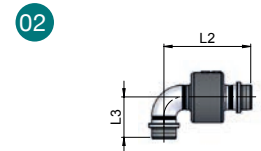
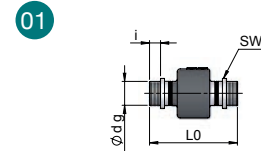
Joint with two ballgroove

Betriebsbedingungen:

Medien	Wasser, Luft/Vakuum, Dampf, Hydrauliköl, Kraftstoff/Gas	
Max. Druck	Stahl DN 125 - DN 300	40 bar
	Stahl DN 350 - DN 700	16 bar
	Edelstahl DN 125 - DN 300	16 bar
	Edelstahl DN 350 - DN 700	6 bar
Max. Temperatur		200 °C
Min. Temperatur	Stahl	-20 °C
	Edelstahl	-50 °C
Max. Drehzahl		< 1 1/min
Größen	DN 125 - 700 (5" - 28")	

Operating data:

Media	water, air/vacuum, steam, hydraulic oil, gasoline/gas	
Max. pressure	steel DN 125 - DN 300	40 bar
	steel DN 350 - DN 700	16 bar
	stainless steel DN 125 - DN 300	16 bar
	stainless steel DN 350 - DN 700	6 bar
Max. temperature		200 °C
Min. temperature	steel	-20 °C
	stainless steel	-50 °C
Max. speed		< 1 rpm
Sizes	DN 125 - 700 (5" - 28")	

- Stahl (42CrMo4) oder Edelstahl (1.4571)
- PTFE-Compound-Dichtung
- kugellagerähnliche Kugelführungsbahn
- Schwenkbewegung, Drehbewegungen bei geringen Drehzahlen

- steel (42CrMo4) or stainless steel (1.4571)
- PTFE-Compound-seal
- built-in ball guiding track similar to ball bearings
- swiveling, rotating movements with low speed

Die Betriebsparameter stehen in Relation zueinander. Daher dürfen die Rohrdrehgelenke bei der Kombination von Betriebsdaten im Maximalbereich nicht ohne Rücksprache mit HAAG + ZEISSLER eingesetzt werden.

The operating parameters are interrelated. Therefore, the swivel joints may not be used with a combination of operating data close to the maximum without first consulting HAAG + ZEISSLER.

Typ SJE
Type SJE



Abb. kann vom Original abweichen!
Picture may differ from original!

Abmessungen (mm) Stahl und Edelstahl Dimensions (mm) steel and stainless steel						
DN	Ø D	Ø d1	Ø di	B	C	G (kg)
125	197	141,3	124,0	125	17,5	12,1
150	223	168,3	150,0	135	22,5	13,5
200	277	219,1	198,7	135	22,5	19,8
250	325	273,0	250,4	135	22,5	23,1
300	390	323,9	301,0	140	25,0	33,4
350	420	355,6	335,0	140	25,0	34,5
400	470	406,4	348,8	140	25,0	39,8
500	590	508,0	485,0	140	25,0	58,0
600	a.A.	a.A.	a.A.	a.A.	a.A.	a.A.
700	a.A.	a.A.	a.A.	a.A.	a.A.	a.A.

Belastung (statisch) load (static)							
DN	Werkstoff 1.7225 Material 1.7225			Werkstoff 1.4571 Material 1.4571			Reibmoment Friction torque Mr (Nm) p = 0
	p max bar	Mb (Nm) p=1 bar	Mb (Nm) p = 16 bar	p max bar	Mb (Nm) p=1 bar	Mb (Nm) p = 6 bar	
125	40,0	10000,0	9000,0	16,0	3000,0	2700,0	30,0
150	40,0	13000,0	11750,0	16,0	4000,0	3500,0	85,0
200	40,0	22000,0	18500,0	16,0	6500,0	5500,0	250,0
250	40,0	32000,0	25500,0	16,0	9500,0	7500,0	350,0
300	40,0	44000,0	34000,0	16,0	13000,0	10000,0	400,0
350	16,0	52000,0	40000,0	6,0	15500,0	11250,0	475,0
400	16,0	67000,0	47500,0	6,0	20000,0	13500,0	525,0
500	16,0	100000,0	67000,0	6,0	30000,0	18000,0	750,0
600	a.A.	a.A.	a.A.	a.A.	a.A.	a.A.	a.A.
700	a.A.	a.A.	a.A.	a.A.	a.A.	a.A.	a.A.

Bitte beachten: die angegebenen Belastungen sind statische Werte. Faktoren wie pulsierender Druck, zusätzliche Axial- bzw. Radialkräfte beeinflussen die Belastbarkeit des Gelenks. Die angegebenen Reibmomente sind nur als Richtwert zu betrachten. Abweichungen sind möglich.

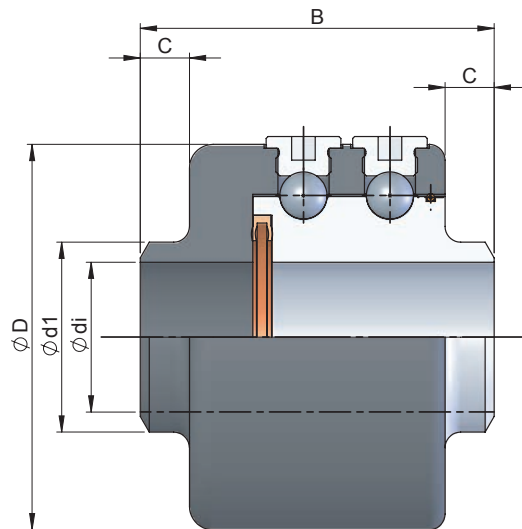
Please note: The loads indicated are static values. Factors such as pulsating pressure, additional axial and / radial forces influence the load capacity of the joint. The specified friction torques are only to be regarded as a guideline. Deviations are possible.

Typ SJE-F
Type SJE-F

Abmessungen (mm) Stahl Dimensions (mm) steel												
DN	Flansche DIN 2632 Flanges DIN 2632				Flansche DIN 2633 Flanges DIN 2633				Flansche DIN 2635 Flanges DIN 2635			
	L0	L1*	L2*	L3*	L0	L1*	L2*	L3*	L0	L1*	L2*	L3*
125					241	385	313,0	185,0	267	385	326,0	198,0
150					251	446	348,5	210,5	291	446	368,5	230,5
200	265	547	406,0	268,0	265	547	406,0	268,0	317	547	432,0	294,0
250	277	649	463,0	325,0	281	649	465,0	327,0	351	649	500,0	362,0
300	282	756	519,0	376,0	302	756	529,0	386,0	376	756	566,0	423,0
350	282	858	570,0	427,0	310	858	584,0	441,0	396	858	627,0	484,0
400	290	959	624,5	481,5	316	959	637,5	494,5	416	959	687,5	544,5
500	296	1162	729,0	586,0								
600	a. A	a. A	a. A	a. A								
700	a. A	a. A	a. A	a. A								

* Kurze Bögen auf Anfrage
* Short elbows on request.

Abmessungen (mm) Edelstahl Dimensions (mm) stainless steel												
DN	Flansche DIN 2632 Flanges DIN 2632				Flansche DIN 2633 Flanges DIN 2633				Flansche DIN 2635 Flanges DIN 2635			
	L0	L1*	L2*	L3*	L0	L1*	L2*	L3*	L0	L1*	L2*	L3*
125					241	511	376	248,0	267	511	389,0	261,0
150					251	598	424,5	286,5	291	598	444,5	306,5
200	265	751	508	370	265	751	508	370,0	317	751	534,0	396,0
250	277	903	590	452	281	903	592,0	454,0	351	903	627,0	489,0
300	282	1060	671	528	302	1060	681,0	538,0	376	1060	718,0	575,0
350	282	1212	747	604	310	1212	761,0	618,0	396	1212	804,0	661,0
400	290	1366	828	685	316	1366	841,0	698,0	416	1366	891,0	748,0
500	296	1670	983	840								
600	a. A	a. A	a. A	a. A								
700	a. A	a. A	a. A	a. A								

ANSI- und SAE-Flansche lieferbar.
ANSI- and SAE-flanges available.

Flanschanschluss
Flange connection



Abb. kann vom Original abweichen!
Picture may differ from original!

Typ SJE-S
Type SJE-S

Abmessungen (mm) Stahl Dimensions (mm) steel						
DN	L0	L1*	L2*	L3*	Ø d	S
125	231	385	308,0	127,0	139,7	4,0
150	241	446	343,5	152,5	168,3	4,5
200	241	547	394,0	203,0	219,1	6,3
250	241	649	445,0	254,0	273,0	6,3
300	246	756	501,0	305,0	323,9	7,1
350	246	858	552,0	356,0	355,6	8,0
400	246	959	602,5	406,5	406,4	a.A.
500	246	1162	703,4	508,0	508,0	a.A.
600	a.A.	a.A.	a.A.	a.A.	a.A.	a.A.
700	a.A.	a.A.	a.A.	a.A.	a.A.	a.A.

Andere Baumaße auf Anfrage
* Kurze Bögen auf Anfrage

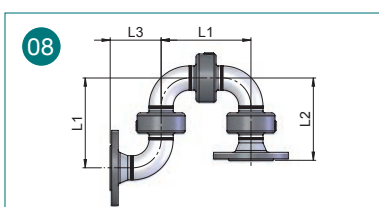
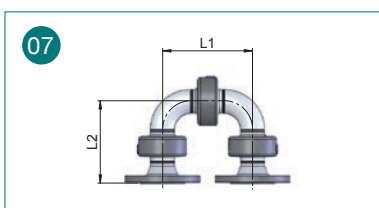
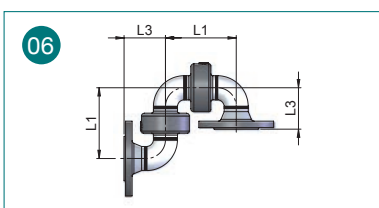
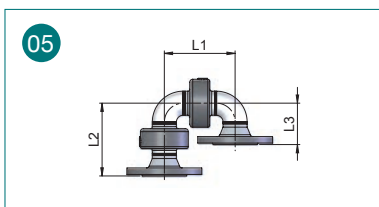
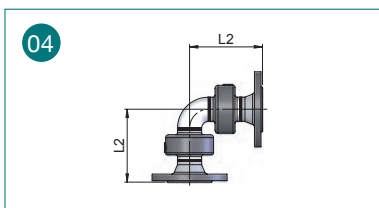
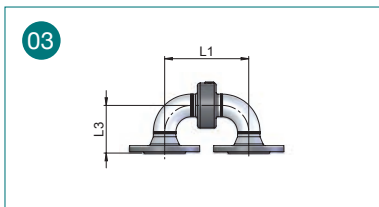
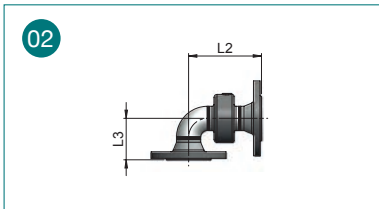
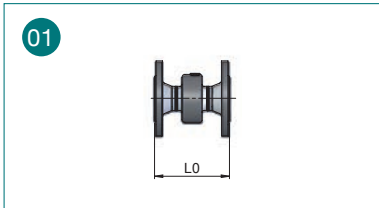
Other dimensions on request.
* Short elbows on request.

Abmessungen (mm) Edelstahl Dimensions (mm) stainless steel						
DN	L0	L1*	L2*	L3*	Ø d	S
125	231	511	371,0	190,0	139,7	4,0
150	241	598	419,5	228,5	168,3	4,5
200	241	751	496,0	305,0	219,1	6,3
250	241	903	572,0	381,0	273,0	6,3
300	246	1060	653,0	457,0	323,9	7,1
350	246	1212	729,0	533,0	355,6	8,0
400	246	1366	806,0	610,0	406,4	a.A.
500	246	1670	957,4	762,0	508,0	a.A.
600	a.A.	a.A.	a.A.	a.A.	a.A.	a.A.
700	a.A.	a.A.	a.A.	a.A.	a.A.	a.A.

Schweißfase
Welding end

01

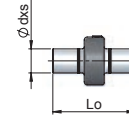

02

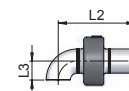

03

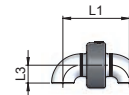

04

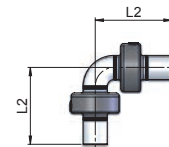

05

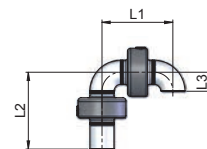

06

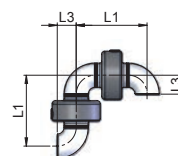

07

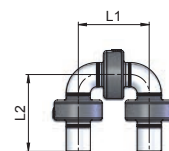

08



Abb. kann vom Original abweichen!
Picture may differ from original!



Abb. kann vom Original abweichen!
Picture may differ from original!

Gelenk mit zwei Kugelführungsbahnen

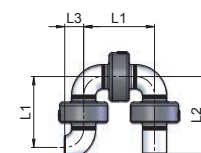
Joint with two ball groove

Betriebsbedingungen:

Medien	Wasser, Luft/Vakuum, Hydrauliköl, Kraftstoff/Gas, Kühlschmierstoff	
Max. Druck	Stahl < 1"	350 bar
	Stahl 1 1/4" - 1 1/2"	315 bar
	Edelstahl < 1"	160 bar
	Edelstahl 1 1/4" - 1 1/2"	100 bar
Max. Temperatur	200 °C	
Min. Temperatur	Stahl	-20 °C
	Edelstahl	-50 °C
Max. Drehzahl	< 5 1/min	
Größen	1/4" - 1 1/2"	

Operating data:

Media	water, air/vacuum, hydraulic oil, gasoline/gas, coolant	
Max. pressure	steel < 1"	350 bar
	steel 1 1/4" - 1 1/2"	315 bar
	stainless steel < 1"	160 bar
	stainless steel 1 1/4" - 1 1/2"	100 bar
Max. temperature	200 °C	
Min. temperature	steel	-20 °C
	stainless steel	-50 °C
Max. speed	< 5 rpm	
Sizes	1/4" - 1 1/2"	

- Stahl (42CrMo4) oder Edelstahl (1.4571)
- PTFE-Compound-Dichtung
- kugellagerähnliche Kugelführungsbahnen
- Schwenkbewegung, Drehbewegungen bei geringen Drehzahlen

- steel (42CrMo4) or stainless steel (1.4571)
- PTFE-Compound-seal
- built-in ball guiding tracks similar to ball bearings
- swiveling, rotating movements with low speed

Die Betriebsparameter stehen in Relation zueinander. Daher dürfen die Rohrdrehgelenke bei der Kombination von Betriebsdaten im Maximalbereich nicht ohne Rücksprache mit HAAG + ZEISSLER eingesetzt werden.

The operating parameters are interrelated. Therefore, the swivel joints may not be used with a combination of operating data close to the maximum without first consulting HAAG + ZEISSLER.

Typ SJK-01
Type SJK-01

AG-AG

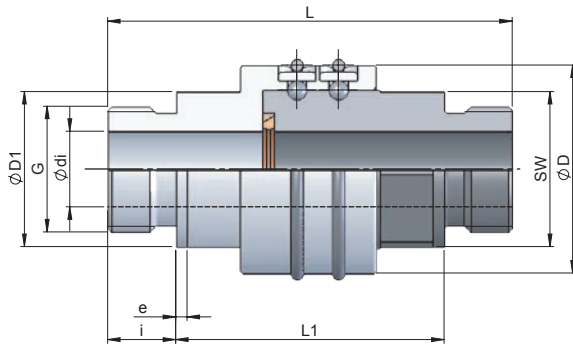

IG-IG



Abb. kann vom Original abweichen!
Picture may differ from original!

Abmessungen (mm) Stahl und Edelstahl, Gewicht
Dimensions (mm) steel and stainless steel, Weights

G	i	Ø di	Ø D	Ø D1	e	L	L1	L2	SW	kg
G 1/4"	12	7	32	19	2,0	68	44	66	22	0,3
G 3/8"	12	9	32	22	2,5	69	45	69	22	0,35
G 1/2"	13	12	38	26	3,0	80	54	78	27	0,45
G 3/4"	16	14	50	32	3,0	98	66	82	32	0,8
G 1"	18	20	55	39	3,0	107	71	107	41	1,0
G 1 1/4"	20	25	60	49	3,0	111	71	110	50	1,5
G 1 1/2"	22	32	70	55	3,0	121	77	113	55	2,1

Andere Baumaße auf Anfrage
Auch mit Schneidringanschlüssen lieferbar

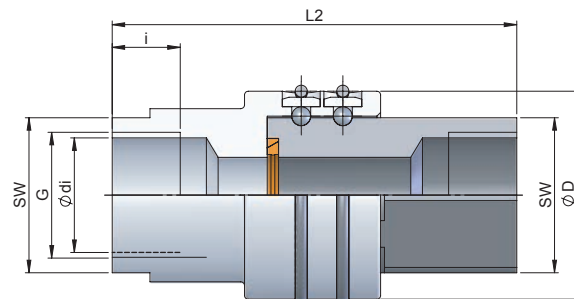
Other dimensions on request
With cutting ring connection available

Belastung (statisch)
load (static)

G	Werkstoff 1.7225 Material 1.7225	Werkstoff 1.4571 Material 1.4571
	p max bar	
G 1/4"	350,0	160,0
G 3/8"	350,0	160,0
G 1/2"	350,0	160,0
G 3/4"	350,0	160,0
G 1"	350,0	160,0
G 1 1/4"	315,0	100,0
G 1 1/2"	315,0	100,0

Bitte beachten: die angegebenen Belastungen sind statische Werte. Faktoren wie pulsierender Druck, zusätzliche Axial- bzw. Radialkräfte beeinflussen die Belastbarkeit des Gelenks. Die angegebenen Reibmomente sind nur als Richtwert zu betrachten. Abweichungen sind möglich.

Please note: The loads indicated are static values. Factors such as pulsating pressure, additional axial and / radial forces influence the load capacity of the joint. The specified friction torques are only to be regarded as a guideline. Deviations are possible.

Typ SJK-01
Type SJK-01

IG-AG

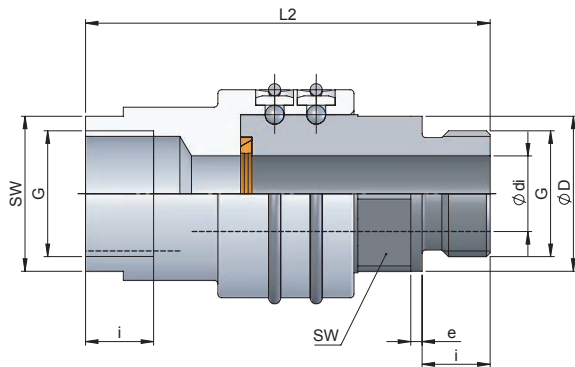

AG-IG

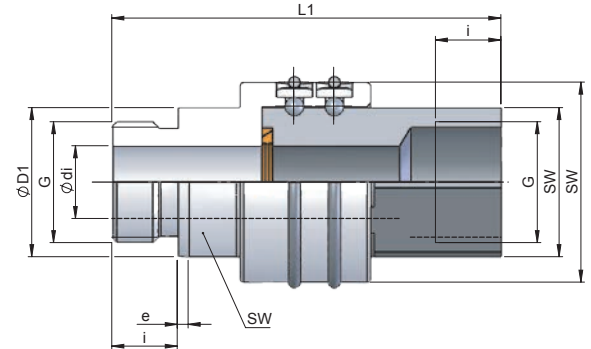

Abmessungen (mm) Stahl und Edelstahl, Gewicht Dimensions (mm) steel and stainless steel, Weights									
DN	i	Ø di	Ø D	Ø D1	e	L1	L2	SW	kg
G 1/4"	12	7	32	19	2,0	68	66	22	0,30
G 3/8"	12	9	32	22	2,5	69	69	22	0,35
G 1/2"	13	12	38	26	3,0	80	80	27	0,45
G 3/4"	16	14	50	32	3,0	90	90	32	0,80
G 1"	18	20	55	39	3,0	107	107	41	1,00
G 1 1/4"	20	25	60	49	3,0	111	110	50	1,50
G 1 1/2"	22	32	70	55	3,0	116	118	55	2,10

Andere Baumaße auf Anfrage
Auch mit Schneidringanschlüssen lieferbar
Other dimensions on request
With cutting ring connection available

Belastung (statisch) load (static)		
G	Werkstoff 1.7225 Material 1.7225	Werkstoff 1.4571 Material 1.4571
p max bar		
G 1/4"	350,0	160,0
G 3/8"	350,0	160,0
G 1/2"	350,0	160,0
G 3/4"	350,0	160,0
G 1"	350,0	160,0
G 1 1/4"	315,0	100,0
G 1 1/2"	315,0	100,0

Bitte beachten: die angegebenen Belastungen sind statische Werte. Faktoren wie pulsierender Druck, zusätzliche Axial- bzw. Radialkräfte beeinflussen die Belastbarkeit des Gelenks. Die angegebenen Reibmomente sind nur als Richtwert zu betrachten. Abweichungen sind möglich.

Please note: The loads indicated are static values. Factors such as pulsating pressure, additional axial and / radial forces influence the load capacity of the joint. The specified friction torques are only to be regarded as a guideline. Deviations are possible.

Typ SJK-02
Type SJK-02

IG-AG

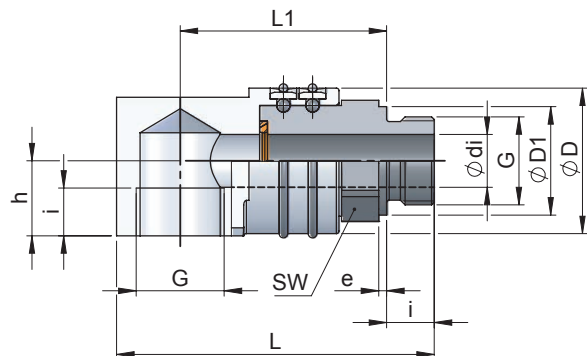

IG-IG

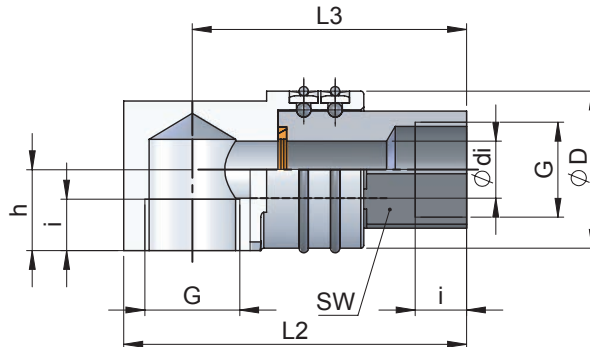

Abmessungen (mm) Stahl und Edelstahl, Gewicht
Dimensions (mm) steel and stainless steel, Weights

DN	i	h	Ø di	Ø D	Ø D1	e	L	L1	L2	L3	SW	kg
G 1/4"	12	15	7	32	19	2,0	70	47	70	59	22	0,35
G 3/8"	12	16	9	32	22	2,5	75	50	75	62	22	0,40
G 1/2"	13	18	12	38	26	3,0	85	56	83	68	27	0,55
G 3/4"	16	24	14	50	32	3,0	105	70	97	78	32	1,10
G 1"	18	28	20	55	39	3,0	120	78	120	96	41	1,40
G 1 1/4"	20	31	25	60	49	3,0	134	84	134	104	50	1,80
G 1 1/2"	22	35	32	70	55	3,0	145	91	140	108	55	2,60

Andere Baumaße auf Anfrage
Auch mit Schneidringanschlüssen lieferbar

Other dimensions on request
With cutting ring connection available

Belastung (statisch)
load (static)

G	Werkstoff 1.7225 Material 1.7225	Werkstoff 1.4571 Material 1.4571
	p max bar	
G 1/4"	350,0	160,0
G 3/8"	350,0	160,0
G 1/2"	350,0	160,0
G 3/4"	350,0	160,0
G 1"	350,0	160,0
G 1 1/4"	315,0	100,0
G 1 1/2"	315,0	100,0

Bitte beachten: die angegebenen Belastungen sind statische Werte. Faktoren wie pulsierender Druck, zusätzliche Axial- bzw. Radialkräfte beeinflussen die Belastbarkeit des Gelenks. Die angegebenen Reibmomente sind nur als Richtwert zu betrachten. Abweichungen sind möglich.

Please note: The loads indicated are static values. Factors such as pulsating pressure, additional axial and / radial forces influence the load capacity of the joint. The specified friction torques are only to be regarded as a guideline. Deviations are possible.



Abb. kann vom Original abweichen!
Picture may differ from original!

Gelenk mit einer Kugelführungsbahn

Joints with one ballgroove

Betriebsbedingungen:

Medien	Wasser, Luft/Vakuum, Hydrauliköl, Kraftstoff/Gas, Kühlschmierstoff	
Max. Druck	Stahl	100 bar
	Edelstahl	40 bar
Max. Temperatur		200 °C
Min. Temperatur	Stahl	-20 °C
	Edelstahl	-50 °C
Max. Drehzahl		< 1 1/min
Größen	DN 8 - DN 50 (1/4" - 2")	

Operating data:

Media	water, air/vacuum, hydraulic oil, gasoline/gas, coolant	
Max. pressure	steel	100 bar
	stainless steel	40 bar
Max. temperature		200 °C
Min. temperature	steel	-20 °C
	stainless steel	-50 °C
Max. speed		< 1 rpm
Sizes	DN 8 - DN 50 (1/4" - 2")	

- Stahl (42CrMo4) oder Edelstahl (1.4571)
- PTFE-Compound-Dichtung
- kugellagerähnliche Kugelführungsbahnen
- Schwenkbewegung, Drehbewegungen bei geringen Drehzahlen

- steel (42CrMo4) or stainless steel (1.4571)
- PTFE-Compound-seal
- built-in ball guiding tracks similar to ball bearings
- swiveling, rotating movements with low speed

Die Betriebsparameter stehen in Relation zueinander. Daher dürfen die Rohrdrehgelenke bei der Kombination von Betriebsdaten im Maximalbereich nicht ohne Rücksprache mit HAAG + ZEISSLER eingesetzt werden.

The operating parameters are interrelated. Therefore, the swivel joints may not be used with a combination of operating data close to the maximum without first consulting HAAG + ZEISSLER.

Typ SJD
Type SJD

01 02 03

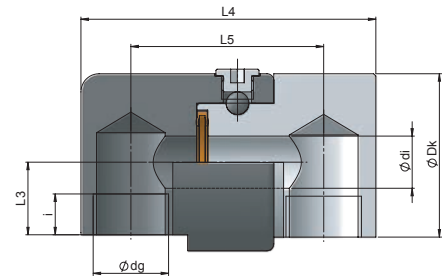
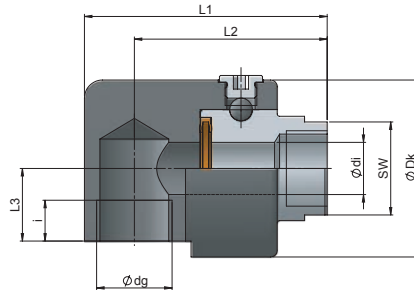
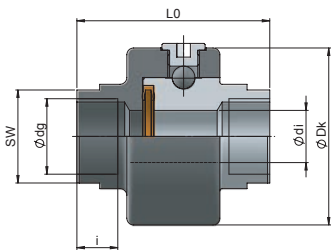

Abmessungen (mm) Stahl und Edelstahl Dimensions (mm) steel and stainless steel												Gewichte Weights		
												Bauformen / Models		
DN	Ø dg	Ø di	i	Ø Dk	SW	L0	L1	L2	L3	L4	L5	01	02	03
8	G 1/4"	17,0	12	72	32	78	92	75	30	110	75	1,30	2,2	2,8
10	G 3/8"	17,0	12	72	32	78	92	75	30	110	75	1,30	1,9	2,8
15	G 1/2"	17,0	14	72	32	78	92	75	30	110	75	1,25	1,9	2,6
20	G 3/4"	17,0	16	72	32	78	92	75	30	110	75	1,25	1,8	2,5
25	G 1"	23,0	18	78	41	85	107	85	32	130	85	1,50	2,7	4,0
32	G 1 1/4"	31,0	20	88	55	85	115	90	33	152	100	2,40	3,6	2,3
40	G 1 1/2"	37,0	22	96	60	90	132	100	35	175	110	2,50	4,7	6,6
50	G 2"	48,5	24	118	70	100	150	110	42	208	128	4,10	7,7	11,4

Andere Baumaße auf Anfrage / NTP-Gewinde lieferbar

Other dimensions on request / NTP-thread available

Belastung (statisch) load (static)							
Werkstoff 1.7225 Material 1.7225				Werkstoff 1.4571 Material 1.4571			Reibmoment Friction torque
DN	p max bar	Mb (Nm) p = 1 bar	Mb (Nm) p = 40 bar	p max bar	Mb (Nm) p = 1 bar	Mb (Nm) p = 25 bar	Mr (Nm) p = 0
8	100	300	250	40	95	70	3,0
10	100	300	250	40	95	70	3,0
15	100	300	250	40	95	70	3,0
20	100	300	250	40	95	70	3,0
25	100	400	350	40	130	80	5,0
32	100	600	500	40	185	110	10,0
40	100	750	600	40	235	125	15,0
50	100	1500	1200	40	460	270	20,0

Bitte beachten: die angegebenen Belastungen sind statische Werte. Faktoren wie pulsierender Druck, zusätzliche Axial- bzw. Radialkräfte beeinflussen die Belastbarkeit des Gelenks. Die angegebenen Reibmomente sind nur als Richtwert zu betrachten. Abweichungen sind möglich.

Please note: The loads indicated are static values. Factors such as pulsating pressure, additional axial and / radial forces influence the load capacity of the joint. The specified friction torques are only to be regarded as a guideline. Deviations are possible.



Abb. kann vom Original abweichen!
Picture may differ from original!

Gelenk mit zwei Kugelführungsbahnen

Joint with two ballgroove

Betriebsbedingungen:

Medien	Wasser, Luft/Vakuum, Hydrauliköl, Kraftstoff/Gas, Kühlschmierstoff	
Max. Druck	Stahl	350 bar
	Edelstahl	100 bar
Max. Temperatur		200 °C
Min. Temperatur	Stahl	-20 °C
	Edelstahl	-50 °C
Max. Drehzahl		< 1 1/min
Größen	DN 8 - DN 50 (1/4" - 2")	

Operating data:

Media	water, air/vacuum, hydraulic oil, gasoline/gas, coolant	
Max. pressure	steel	350 bar
	stainless steel	100 bar
Max. temperature		200 °C
Min. temperature	steel	-20 °C
	stainless steel	-50 °C
Max. speed		< 1 rpm
Sizes	DN 8 - DN 50 (1/4" - 2")	

- Stahl (42CrMo4) oder Edelstahl (1.4571)
- PTFE-Compound-Dichtung
- kugellagerähnliche Kugelführungsbahnen
- Schwenkbewegung, Drehbewegungen bei geringen Drehzahlen

- steel (42CrMo4) or stainless steel (1.4571)
- PTFE-Compound-seal
- built-in ball guiding tracks similar to ball bearings
- swiveling, rotating movements with low speed

Die Betriebsparameter stehen in Relation zueinander. Daher dürfen die Rohrdrehgelenke bei der Kombination von Betriebsdaten im Maximalbereich nicht ohne Rücksprache mit HAAG + ZEISSLER eingesetzt werden.

The operating parameters are interrelated. Therefore, the swivel joints may not be used with a combination of operating data close to the maximum without first consulting HAAG + ZEISSLER.

Typ SJC
Type SJC

01 02 03

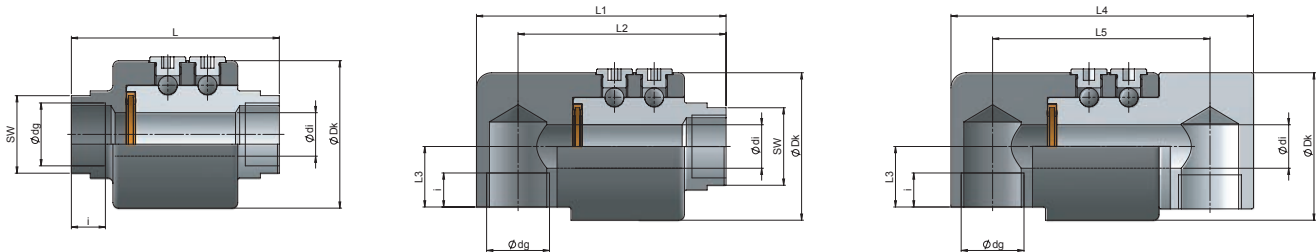

Abmessungen (mm) Stahl und Edelstahl Dimensions (mm) steel and stainless steel												Gewichte Weights		
												Bauformen / Models		
DN	Ø dg	Ø di	i	Ø Dk	SW	L	L1	L2	L3	L4	L5	01	02	03
8	G 1/4	17,0	12	72	32	110	132	110	30	154	110	2,8	3,9	5,0
10	G 3/8	17,0	12	72	32	110	132	110	30	154	110	2,8	3,9	5,0
15	G 1/2	17,0	14	72	32	110	132	110	30	154	110	2,7	3,8	4,8
20	G 3/4	17,0	16	72	32	110	132	110	30	154	110	2,7	3,8	4,8
25	G 1	23,0	18	78	41	110	132	110	32	160	115	2,9	3,9	5,2
32	G 1 1/4	31,0	20	88	55	120	158	125	34	200	132	3,5	5,2	7,2
40	G 1 1/2	37,0	22	104	60	120	158	125	40	200	132	4,1	7,0	9,9
50	G 2	48,5	24	118	70	145	190	150	40	235	155	5,8	8,6	11,5

Andere Baumaße auf Anfrage / NTP-Gewinde lieferbar
Other dimensions on request / NTP-thread available

Belastung (statisch) load (static)							
Werkstoff 1.7225 Material 1.7225				Werkstoff 1.4571 Material 1.4571			Reibmoment Friction torque
DN	p max bar	Mb (Nm) p = 1 bar	Mb (Nm) p = 40 bar	p max bar	Mb (Nm) p = 1 bar	Mb (Nm) p = 40 bar	Mr (Nm) p = 0
8	350	550	500	100	200	160	3,0
10	350	550	500	100	200	160	3,0
15	350	550	500	100	200	160	3,0
20	350	550	500	100	200	160	3,0
25	350	750	675	100	275	200	5,0
32	350	1000	950	100	400	300	10,0
40	350	1500	1250	100	550	360	15,0
50	350	2700	2400	100	1000	700	20,0

Bitte beachten: die angegebenen Belastungen sind statische Werte. Faktoren wie pulsierender Druck, zusätzliche Axial- bzw. Radialkräfte beeinflussen die Belastbarkeit des Gelenks. Die angegebenen Reibmomente sind nur als Richtwert zu betrachten. Abweichungen sind möglich.

Please note: The loads indicated are static values. Factors such as pulsating pressure, additional axial and / radial forces influence the load capacity of the joint. The specified friction torques are only to be regarded as a guideline. Deviations are possible.



Abb. kann vom Original abweichen!
Picture may differ from original!

Kugellagerertes Gelenk

Ball bearing mounted joint

Betriebsbedingungen:

Medien	Wasser, Luft/Vakuum, Kraftstoff/Gas, Kühlschmierstoff	
Max. Druck	1/4" - 1/2"	200 bar
	3/4"	150 bar
	1"	100 bar
	1 1/4" - 1 1/2"	80 bar
Max. Temperatur		90 °C
Min. Temperatur	Stahl	-20 °C
Max. Drehzahl		< 5 1/min
Größen		1/4" - 1 1/2"

Operating data:

Media	water, air/vacuum, gasoline/gas, coolant	
Max. pressure	1/4" - 1/2"	200 bar
	3/4"	150 bar
	1"	100 bar
	1 1/4" - 1 1/2"	80 bar
Max. temperature		90 °C
Min. temperature	steel	-20 °C
Max. speed		< 5 rpm
Sizes		1/4" - 1 1/2"

- Stahl (verzinkt)
- NBR-Dichtung
- Kugellager-Ausführung
- Schwenkbewegung, Drehbewegungen bei geringen Drehzahlen
- für einfache Anwendungen, z. B. Schlauchtrommeln

- steel (zinc plated)
- NBR-seal
- Ball bearing version
- swiveling, rotating movements with low speed
- for simple applications for example hose reels

Die Betriebsparameter stehen in Relation zueinander. Daher dürfen die Rohrdrehgelenke bei der Kombination von Betriebsdaten im Maximalbereich nicht ohne Rücksprache mit HAAG + ZEISSLER eingesetzt werden.

The operating parameters are interrelated. Therefore, the swivel joints may not be used with a combination of operating data close to the maximum without first consulting HAAG + ZEISSLER.

Typ SJN-01
Type SJN-01



Verlinkt – durch klicken
auf die Bestellnummer
Hyperlink – by clicking
on the ordering codes



Abb. kann vom Original abweichen!
Picture may differ from original!

Abmessungen (mm) Stahl, Gewicht Dimensions (mm) steel, Weights								
Bestell-Nr. Ordering-code	G	ØD	Ød	SW	e	L	i	kg
952998	1/4"	33	8	19	12	67	11	0,25
952999	3/8"	35	10	24	13	69,5	12	0,35
953000	1/2"	42	13	27	14	78	13	0,4
953001	3/4"	50	18,5	34	16	91	20	0,6
953002	1"	55	20	41	22	98,5	20	0,85
953003	1 1/4"	62	27	50	22	105	22	1,0
953004	1 1/2"	70	33	55	24	118	25	1,5

Typ SJN-02
Type SJN-02

< = 1/2"

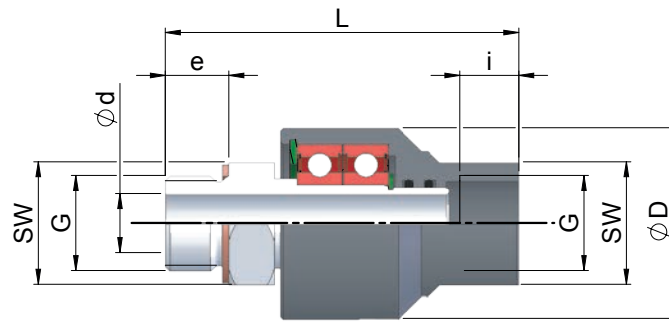
> 1/2"



Abb. kann vom Original abweichen!
Picture may differ from original!

Abmessungen (mm) Stahl, Gewicht Dimensions (mm) steel, Weights											
Bestell-Nr. Ordering-code	G	ØD1	ØD2	Ød	SW	e	L1	L2	L3	i	kg
952996	1/4"	33	-	8	19	12	69	59	13,5	11	0,4
952997	3/8"	35	-	10	24	13	74	63	13,5	12	0,45
953200	1/2"	42	-	13	27	14	90	76	15	13	0,6
953201	3/4"	50	57	18,5	34	16	104	85	22,5	15	1,2
953202	1"	55	63	20	41	22	118,5	96,5	24	21	1,6
953203	1 1/4"	62	73	27	50	22	134	107,5	27	24	2,0
953204	1 1/2"	70	82	33	55	24	148	119	29	26	2,6

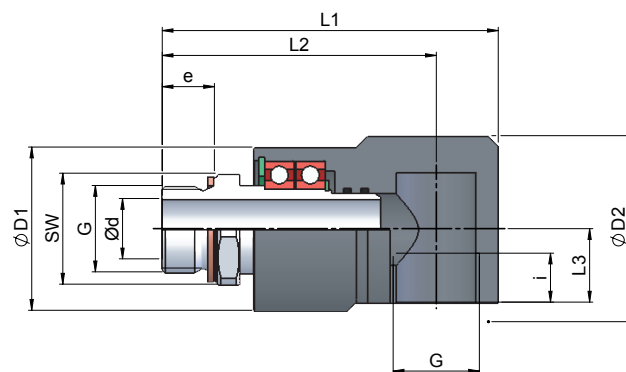
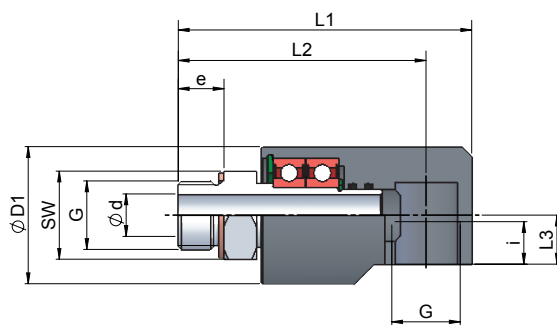

Abb. kann vom Original abweichen!
Picture may differ from original!

Schlauchdrehgelenk

Betriebsbedingungen:

Medien	Wasser, Luft/Vakuum, Hydrauliköl, Kraftstoff/Gas, Kühlschmierstoff	
Max. Druck		16 bar
Max. Temperatur		120 °C
Min. Temperatur		-20 °C
Max. Drehzahl		< 1 1/min
Größen		1/2" - 4"

- Messing oder Edelstahl
- Viton-Dichtung (FEP optional)
- Kugellagerähnliche Kugelführungsbahnen
- Schwenkbewegung, Drehbewegungen bei geringen Drehzahlen
- für einfache Anwendungen, z. B. Schlauchtrommeln

Die Betriebsparameter stehen in Relation zueinander. Daher dürfen die Rohrdrehgelenke bei der Kombination von Betriebsdaten im Maximalbereich nicht ohne Rücksprache mit HAAG + ZEISSLER eingesetzt werden.

Swivel hose joint

Operating data:

Media	water, air/vacuum, hydraulic oil, gasoline/gas, coolant	
Max. pressure		16 bar
Max. temperature		120 °C
Min. temperature		-20 °C
Max. speed		< 1 rpm
Sizes		1/2" - 4"

- brass or stainless steel
- Viton-seal (FEP optional)
- built-in ball guiding tracks similar to ball bearings
- swiveling, rotating movements with low speed
- for simple applications for example hose reels

The operating parameters are interrelated. Therefore, the swivel joints may not be used with a combination of operating data close to the maximum without first consulting HAAG + ZEISSLER.

Typ SDG
Type SDG

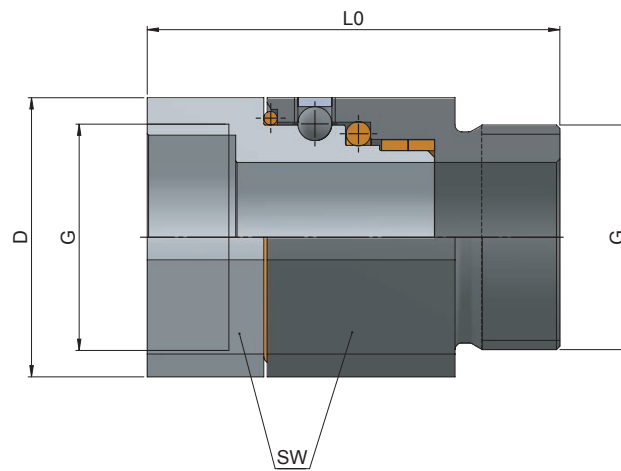

Abmessungen (mm) Messing und Edelstahl Dimensions (mm) brass and stainless steel				
DN	G	D	L0	SW
15	G 1/2"	34,0	52,0	32
20	G 3/4"	38,0	53,0	36
25	G 1"	44,0	60,5	41
32	G 1 1/4"	53,0	56,0	50
40	G 1 1/2"	58,0	62,0	55
50	G 2"	74,5	73,5	70
65	G 2 1/2"	90,0	77,5	85
80	G 3"	105,0	79,5	100
100	G 4"	130,0	82,5	125

Andere Baumaße auf Anfrage / NTP-Gewinde lieferbar

Other dimensions on request / NTP-thread available

Gewichte (kg) Weights (kg)		
DN	Edelstahl	Messing
15	0,21	0,23
20	0,24	0,26
25	0,34	0,37
32	0,44	0,48
40	0,57	0,62
50	0,95	1,05
65	1,28	1,36
80	1,65	1,80
100	2,25	2,45



Abb. kann vom Original abweichen!
Picture may differ from original!

Direktflanschgelenke

Direct flanged swivels

Betriebsbedingungen:

Medien	Wasser, Luft/Vakuum, Dampf, Hydrauliköl, Kraftstoff/Gas	
Max. Druck		40 bar
Max. Temperatur		200 °C
Min. Temperatur	Stahl	-20 °C
	Edelstahl	-50 °C
Max. Drehzahl		< 1 1/min
Größen	SDF 1	DN 50 - 100 (2" - 4")
	SDF 2	DN 50 - 800 (2" - 32")

Operating data:

Media	water, air/vacuum, steam, hydraulic oil, gasoline/gas	
Max. pressure		40 bar
Max. temperature		200 °C
Min. temperature	steel	-20 °C
	stainless steel	-50 °C
Max. speed		< 1 rpm
Sizes	SDF 1	DN 50 - 100 (2" - 4")
	SDF 2	DN 50 - 800 (2" - 32")

- Stahl (42CrMo4) oder Edelstahl (1.4571)
- PTFE-Compound-Dichtung
- kugellagerähnliche Kugelführungsbahn
- Schwenkbewegung, Drehbewegungen bei geringen Drehzahlen
- kurze Baulänge

- steel (42CrMo4) or stainless steel (1.4571)
- PTFE-Compound-seal
- built-in ball guiding track similar to ball bearings
- swiveling, rotating movements with low speed
- short length

Die Betriebsparameter stehen in Relation zueinander. Daher dürfen die Rohrdrehgelenke bei der Kombination von Betriebsdaten im Maximalbereich nicht ohne Rücksprache mit HAAG + ZEISSLER eingesetzt werden.

The operating parameters are interrelated. Therefore, the swivel joints may not be used with a combination of operating data close to the maximum without first consulting HAAG + ZEISSLER.

Typ SDF1
Type SDF1

Typ SDF2
Type SDF2

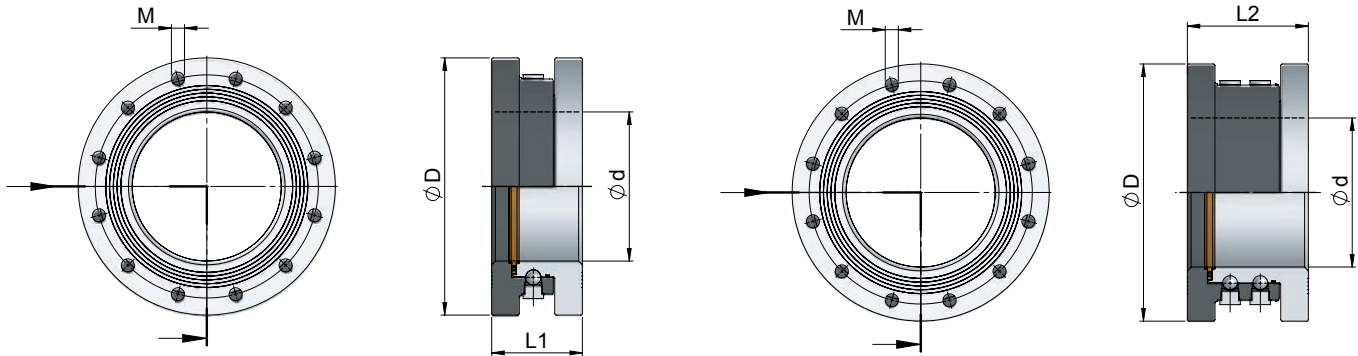

Abmessungen (mm) Stahl und Edelstahl
Dimensions (mm) steel and stainless steel

DN	Flansch DIN 2632					Flansch DIN 2633					Flansch DIN 2635				
	Ø D	Ø d	M	L1	L2	Ø D	Ø d	M	L1	L2	Ø D	Ø d	M	L1	L2
50	165	48,5	M16	95	120	165	48,5	M16	95	120	165	48,5	M16	95	120
65	185	58,6	M16	95	120	185	58,6	M16	95	120	185	58,6	M16	95	120
80	198	73,9	M16	105	110	198	73,9	M16	105	110	198	73,9	M16	105	110
100	217	98,0	M16	105	125	217	98,0	M16	105	125	235	98,0	M20	105	130
125	250	124	M16		130	250	124	M16		130	270	124	M24	105	130
150	285	150,0	M20		140	285	150,0	M20		140	300	150,0	M24	110	140
200	340	198,7	M20		125	340	198,7	M20		125					
250	395	250,4	M20		120	405	250,4	M24		120					
300	445	301	M20		130	460	301	M24		130					

Diese Baureihe ist auf Anfrage bis Größe DN 800 lieferbar
Andere Baumaße auf Anfrage

This series is available up to size DN 800 on request
Other dimensions on request

Typ SDF1
Type SDF1

Belastung (statisch) load (static)						
DN	PN	Werkstoff 1.7225 Material 1.7225		Werkstoff 1.4571 Material 1.4571		Reibmoment Friction torque Mr (Nm) p = 0
		Mb (Nm) p=1 bar	Mb (Nm) p = 40 bar	Mb (Nm) p=1 bar	Mb (Nm) p = 40 bar	
50	10	1 500	1 200	460	270	20,0
	16	1 500	1 200	460	270	20,0
	40	1 500	1 200	460	270	20,0
65	10	2 000	1 500	650	280	25,0
	16	2 000	1 500	650	280	25,0
	40	2 000	1 500	650	280	25,0
80	10	2 350	1 650	725	285	30,0
	16	2 350	1 650	725	285	30,0
	40	2 350	1 650	725	285	30,0
100	10	3 500	2 300	1 000	300	35,0
	16	3 500	2 300	1 000	300	35,0
	40	3 500	2 300	1 000	300	35,0
125	10	a.A.	a.A.	a.A.	a.A.	a.A.
	16	a.A.	a.A.	a.A.	a.A.	a.A.
	40	a.A.	a.A.	a.A.	a.A.	a.A.
150	10	a.A.	a.A.	a.A.	a.A.	a.A.
	16	a.A.	a.A.	a.A.	a.A.	a.A.
	40	a.A.	a.A.	a.A.	a.A.	a.A.
200	10	a.A.	a.A.	a.A.	a.A.	a.A.
	16	a.A.	a.A.	a.A.	a.A.	a.A.
250	10	a.A.	a.A.	a.A.	a.A.	a.A.
	16	a.A.	a.A.	a.A.	a.A.	a.A.
300	10	a.A.	a.A.	a.A.	a.A.	a.A.
	16	a.A.	a.A.	a.A.	a.A.	a.A.

Diese Baureihe ist auf Anfrage bis Größe DN 800 lieferbar

Bitte beachten: die angegebenen Belastungen sind statische Werte. Faktoren wie pulsierender Druck, zusätzliche Axial- bzw. Radialkräfte beeinflussen die Belastbarkeit des Gelenks. Die angegebenen Reibmomente sind nur als Richtwert zu betrachten. Abweichungen sind möglich.

Typ SDF2
Type SDF2

Belastung (statisch) load (static)						
DN	PN	Werkstoff 1.7225 Material 1.7225		Werkstoff 1.4571 Material 1.4571		Reibmoment Friction torque Mr (Nm) p = 0
		Mb (Nm) p=1 bar	Mb (Nm) p = 40 bar	Mb (Nm) p=1 bar	Mb (Nm) p = 40 bar	
50	10	2 700	2 400	1 000	700	20,0
	16	2 700	2 400	1 000	700	20,0
	40	2 700	2 400	1 000	700	20,0
65	10	3 750	3 250	1 400	850	25,0
	16	3 750	3 250	1 400	850	25,0
	40	3 750	3 250	1 400	850	25,0
80	10	4 250	3 500	1 600	900	30,0
	16	4 250	3 500	1 600	900	30,0
	40	4 250	3 500	1 600	900	30,0
100	10	7 250	6 000	2 750	1 250	35,0
	16	7 250	6 000	2 750	1 250	35,0
	40	7 250	6 000	2 750	1 250	35,0
125	10	10 000	9 000	3 000	2 700	30,0
	16	10 000	9 000	3 000	2 700	30,0
	40	10 000	9 000	3 000	2 700	30,0
150	10	13 000	11 750	4 000	3 500	85,0
	16	13 000	11 750	4 000	3 500	85,0
	40	13 000	11 750	4 000	3 500	85,0
200	10	22 000	18 500	6 500	5 500	250,0
	16	22 000	18 500	6 500	5 500	250,0
250	10	32 000	25 500	9 500	7 500	350,0
	16	32 000	25 500	9 500	7 500	350,0
300	10	44 000	34 000	13 000	10 000	400,0
	16	44 000	34 000	13 000	10 000	400,0

This series is available up to size DN 800 on request

Please note: The loads indicated are static values. Factors such as pulsating pressure, additional axial and / radial forces influence the load capacity of the joint. The specified friction torques are only to be regarded as a guideline. Deviations are possible.

Weitere Produkte

Other Products



Gelenkscheren
Pipe scissors
Verladearme
Loading arms



Schnellkupplungen
Quick-release couplings

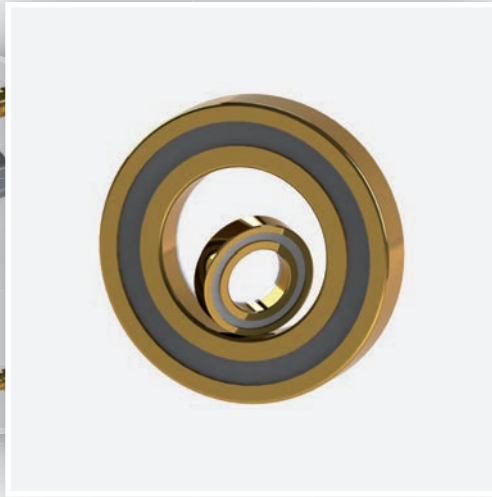

Feststoffgeschmierte Kugellager bis 400 °C
– wartungsfrei –
Bearings with solid lubrication up to 400 °C
– maintenance free –



Nirostahlschläuche
Flexible stainless steel hoses



Sonderbauten
Special constructions



Am Steinheimer Tor 18
63450 Hanau (Germany)

Telefon +49 6181 92387-0
Telefax +49 6181 92387-20

info@haag-zeissler.com
www.haag-zeissler.com